

United Hip System



Comprehensive Hip Replacement System –

The United Hip System offers surgeons the ability to meet various patient needs through providing a comprehensive portfolio of stem and cup products from bone stock preservation to complex revision arthroplasty.

Based on the anatomy, kinematics, biomechanics, engineering and material technologies, the United Hip System offers tapered stem, cylindrical stem and cemented stem, with different fixation concepts and acetabular cup systems to satisfy different patient needs.

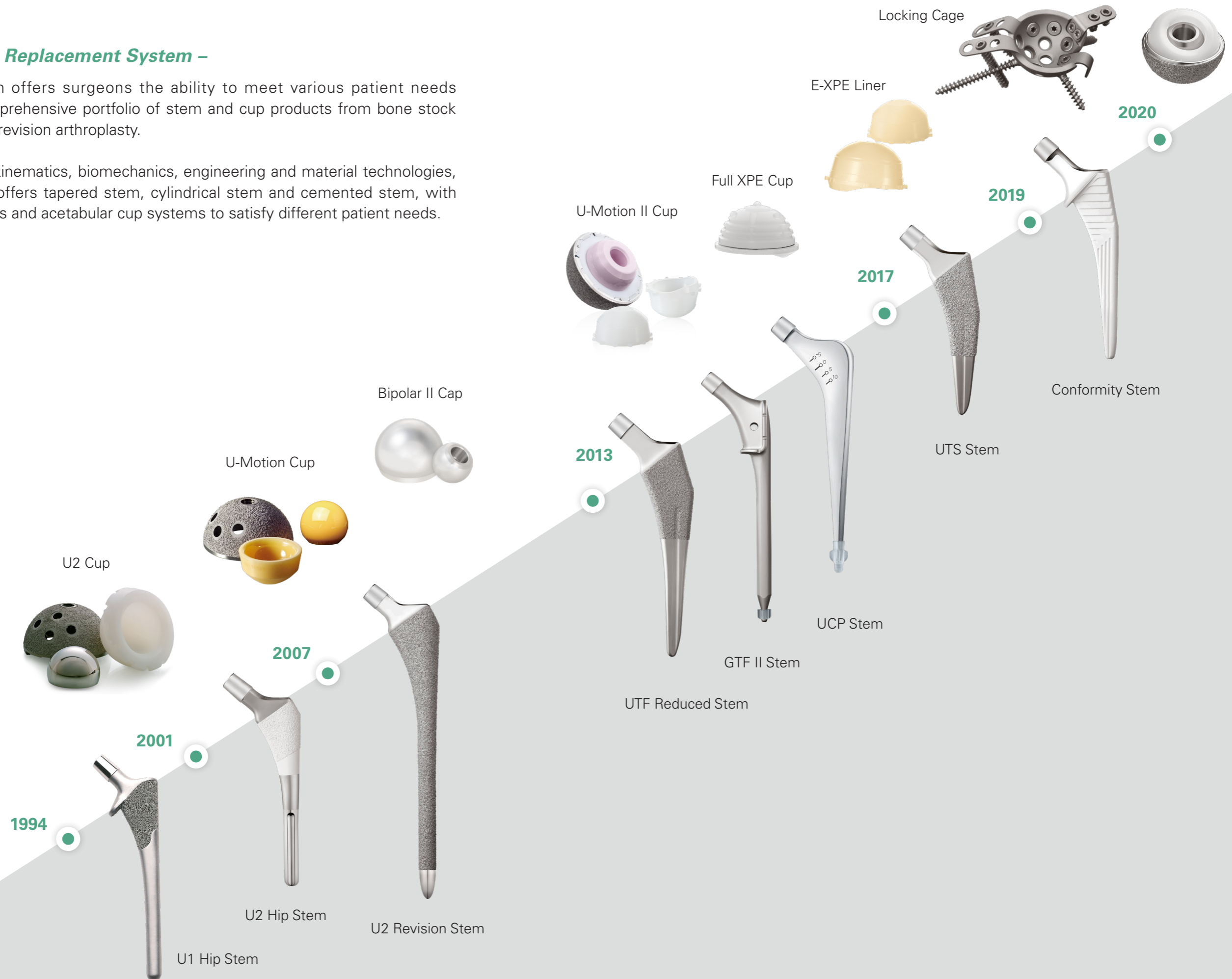

Overview

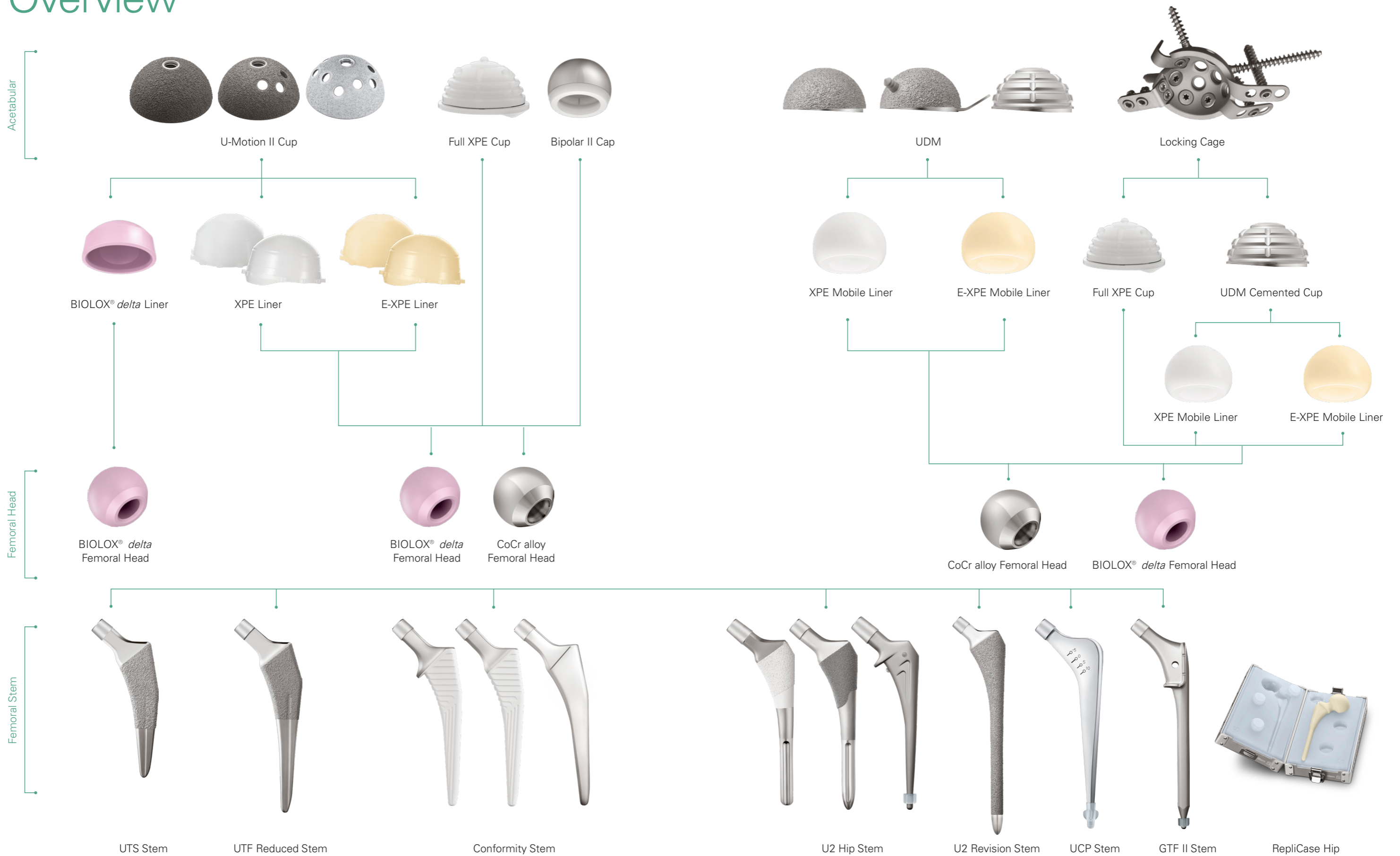

*BIOLOX® is a registered trademark of the CeramTec Group, Germany

U-Motion II™ Cup

Comprehensive cementless acetabular system

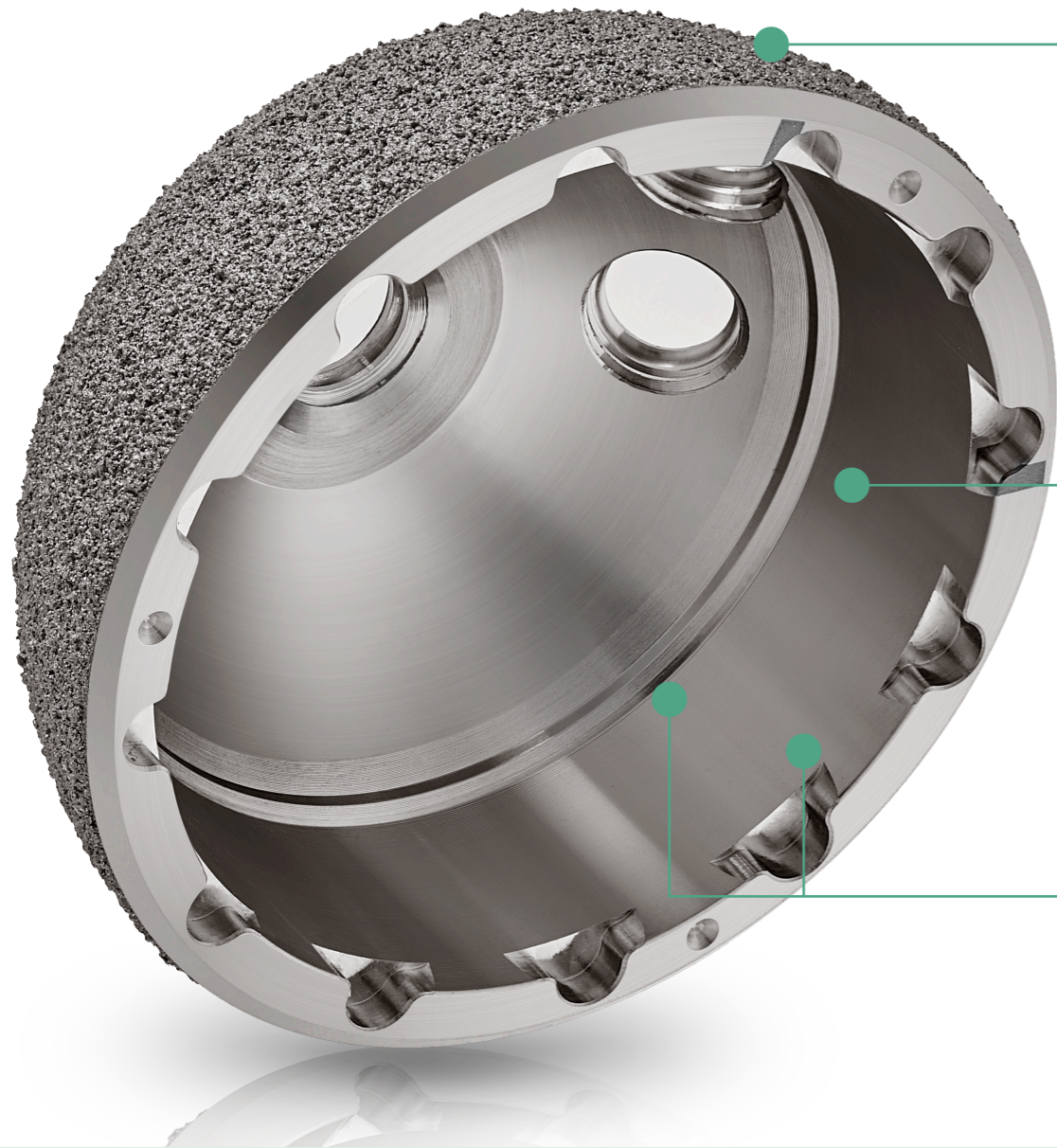

Four Coating Surfaces Designed to Improve Biological Fixation

- Titanium Plasma Spray (TPS)
- Titanium Plasma Spray with Hydroxyapatite (HA)
- Titanium Plasma Spray PLUS (TPS PLUS)
- Titanium Plasma Spray PLUS with Hydroxyapatite (HA)

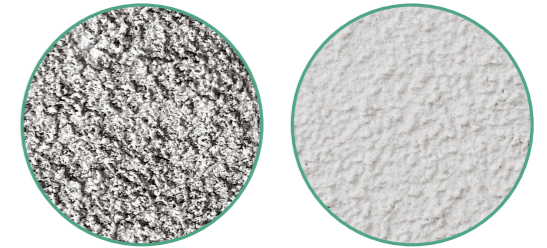

Multiple Cup Configurations

- No-hole, cluster-hole, and multi-hole cup configuration are available from 44 mm to 70 mm



Universal Locking Mechanism

- U-Motion II acetabular cup can be used with polyethylene and ceramic liner

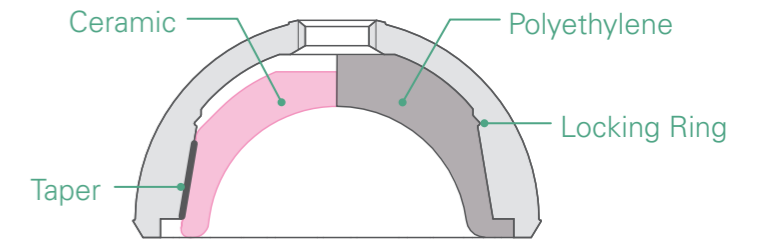

Three Liner Material Options are Available



E-XPE
(Vitamin E Highly Crosslinked Polyethylene)



XPE
(Highly Crosslinked Polyethylene)



BILOX® delta

Standard and 20 ° lipped poly liners are available in XPE and E-XPE material.

Two Femoral Head Material Options are Available

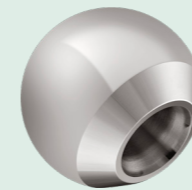

Cobalt Chrome (CoCr)



BILOX® delta

UDM™

Mobile bearing hip solution for demanding situations

The United Dual Mobility Cup series provides ideal solutions with large mobile liner which maximize the jumping distance to help prevent joint dislocation, and increases the full range of motion for functional high-demand users.

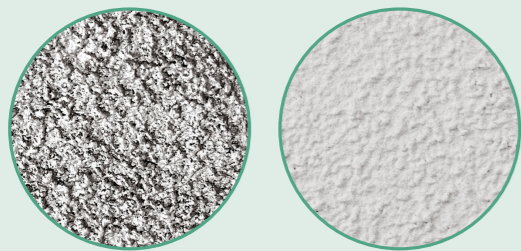

Coating Surfaces

- TPS PLUS
- TPS PLUS with HA

Several bone / implant interface are prepared for achieving the ideal long-term stability.



Press-fit



Peg-fixed



Cemented

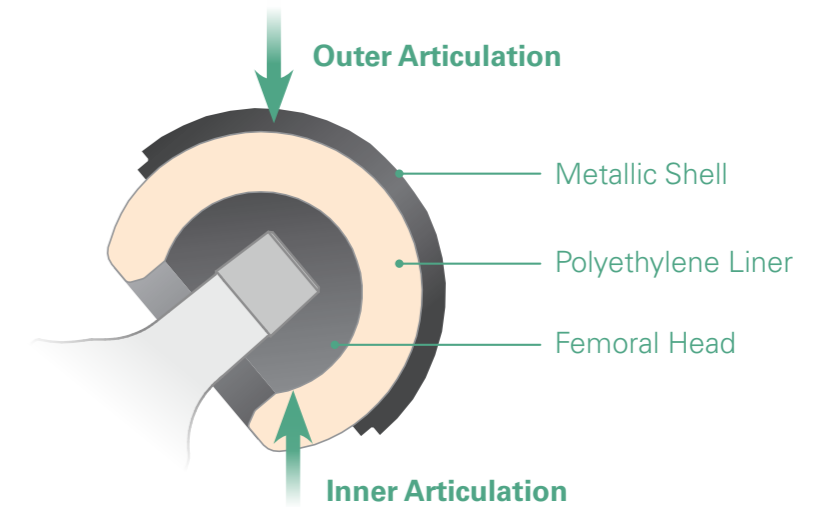
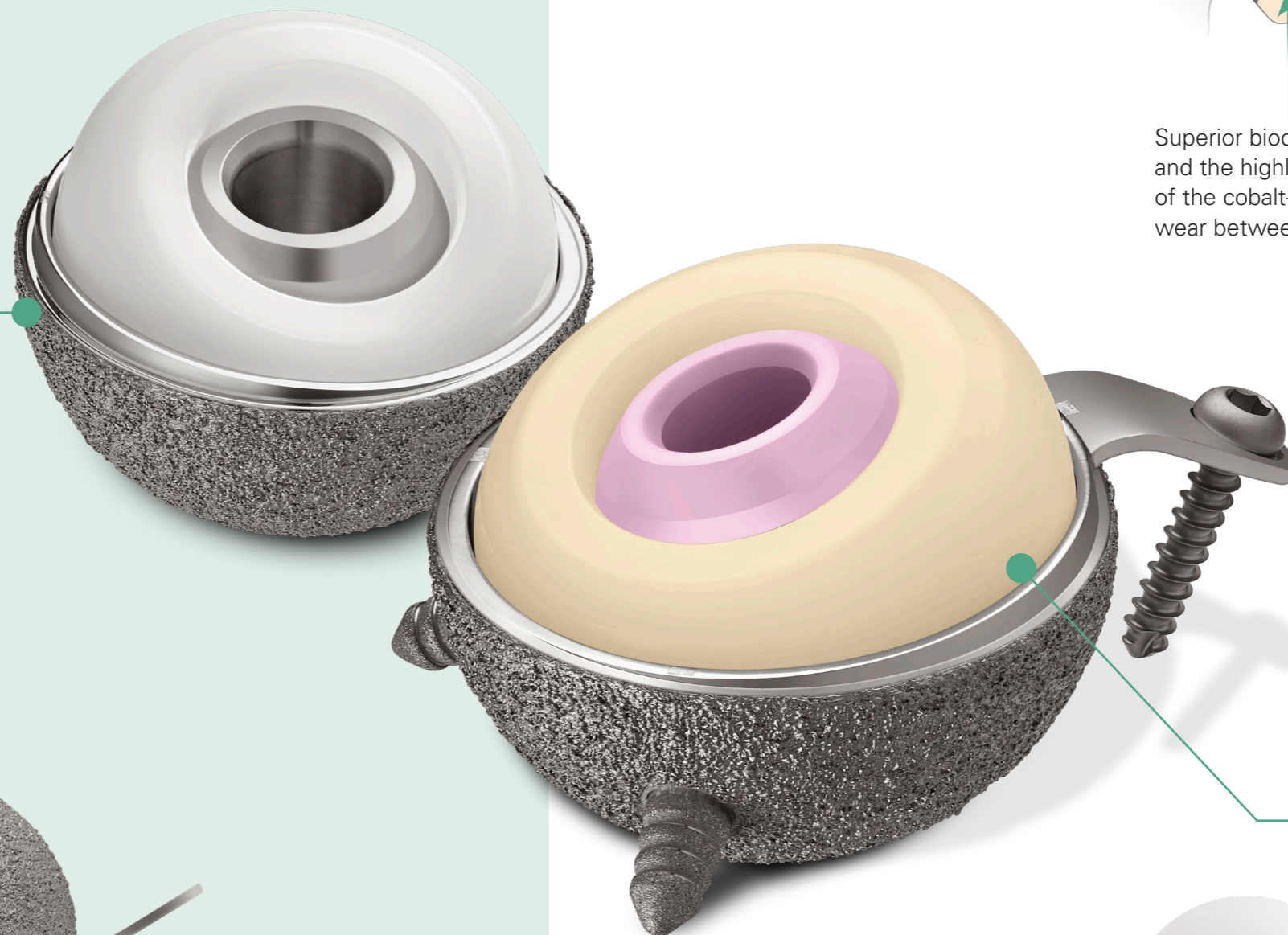

Superior biocompatibility, mechanical durability, and the highly polished finish of the inner surface of the cobalt-chrome alloy cup helps to reduce wear between the cup and the liner.

Mobile Liner Material Options



XPE Mobile Liner



E-XPE Mobile Liner

Full XPE™ Cup

All poly cemented acetabular solution for hip arthroplasty

Designed for cemented fixation in primary or revision hip arthroplasty.

Bipolar II™ Cap

Solution for hemi-arthroplasty

One-piece assembly with simple locking ring mechanism designed to allow surgical efficiency while maintaining strength.

XPE Material

- Made from XPE material, the Full XPE cup is designed to provide optimal stability and improved longevity

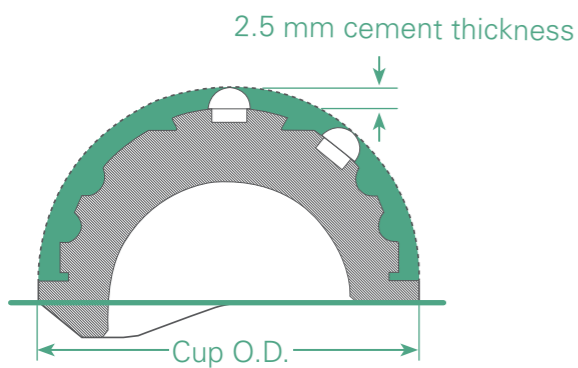

Uniform 2.5 mm cement thickness designed to help even the load transfer to the cement and bone

Highly Polished Surface

- Designed to reduce the wear of the acetabulum

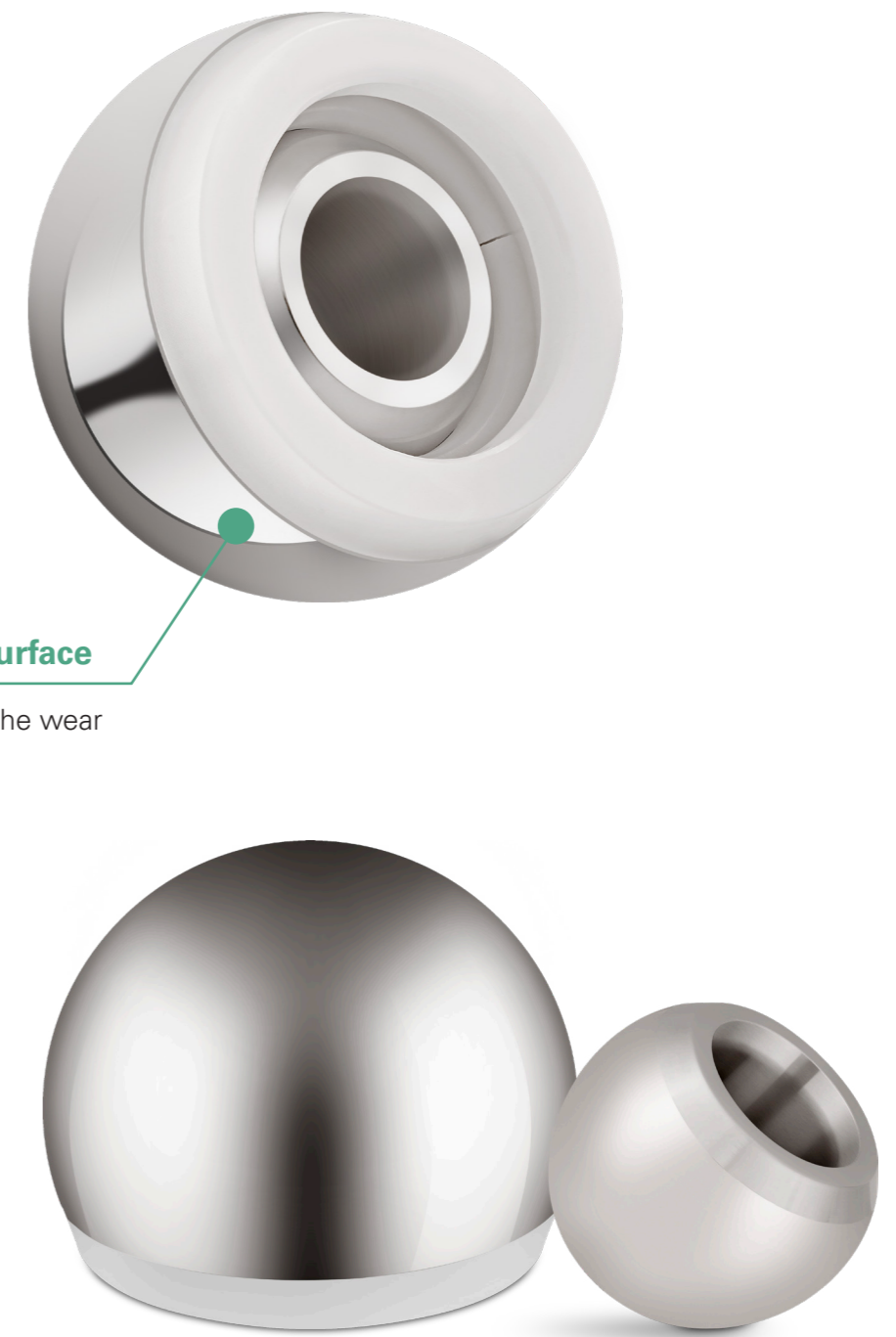

UTS™ Stem

Ideal for the MIS Approach

UTF™ Reduced Stem

Taper-fit Fixation



Tri-tapered Design

- Helps to ensure primary fixation while providing rotational stability

Shorter Stem Length

- Allows for the potential to preserve more host bone and improve implant fixation

TPS and TPS with HA Coating

- Designed to improve biological fixation

Consistent Size Increment in UTS

- Consistent 1.5 mm increment in width enables surgeons to properly size the implant

Dual Taper Design

- Intended to engage the cortex in the stem corners to provide excellent fixation
- Provide superior axial and rotational stability

TPS Coating

- Designed to improve biological fixation

Refined Proximal Width in UTF

- 1.0 mm proximal width increments between commonly used sizes enables the surgeon to optimize between different metaphyseal widths

Conformity™ Stem

Conform to reality

The Conformity Stem platform provides a comprehensive stem solution to hip arthroplasty surgery.

Following the classic concept of a fully-hydroxyapatite (HA) coating on the stem, multiple neck options, collared and collarless features, cementless and cemented options are available for surgeons to offer 77 various solutions for clinical situations, and to provide the implant that best meets the patient's needs.

A compaction broaching technique is utilized to help provide initial stability and preserve bone stock and blood supply.



4 Options for Neck Restoration

- Standard
- High Offset
- Coxa Vara
- Short Neck

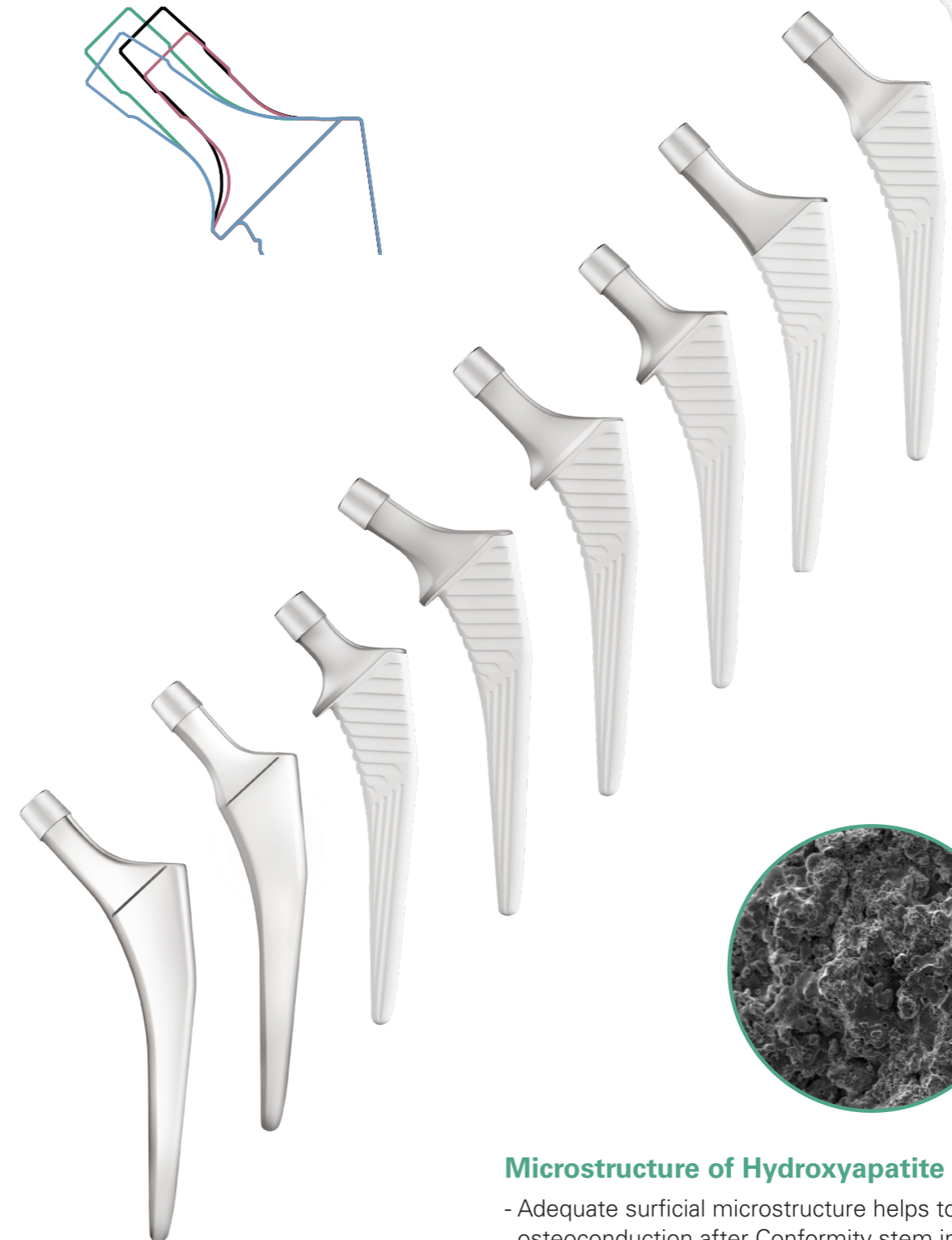

Microstructure of Hydroxyapatite Coating

- Adequate surficial microstructure helps to promote ideal osteoconduction after Conformity stem insertion

U2™ Hip Stem

Novel matrix sizing enables optimal fit and fill

Tri-wedge Design

- Provides axial and rotational stability
- Helps achieve normal proximal load transfer and reduce the potential for stem subsidence



U2 Cemented Stem

U2 Matrix HA Stem



U2 Matrix Porous Stem



Back Up Solution

- U2 Cemented Stem shares the same instruments with U2 Matrix Stems and preserves the appropriate cement thickness around the stem to help ensure optimal canal fit

Matrix Sizing

- Addresses both proximal and distal canal "fit-and-fill" in order to achieve optimal load transfer and excellent initial stability in a variety of femoral canal shapes

Proximal Size (#, Size)	#7							#7
	#6					#6	#6	
	#5				#5	#5		
	#4			#4	#4			
	#3		#3	#3	#3			
	#2		#2	#2				
	#1		#1					
	#0	#0						
	#0	8	9	10	11	12	13	14
		Distal Diameter (Ø, mm)						

Matrix sizing distribution chart for U2 Matrix Porous Stem and U2 Matrix HA Stem

Examples of Matrix Size Distribution

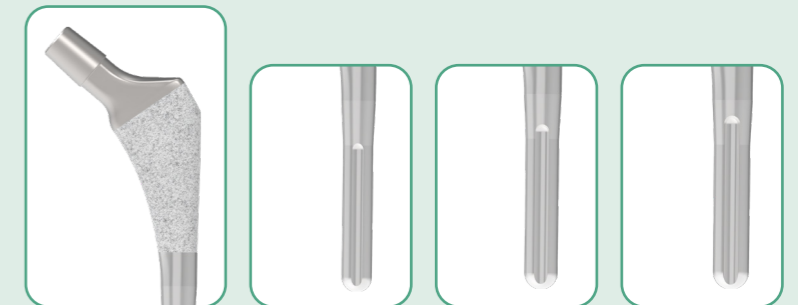

- Proximal size 3 is available in 10, 11 and 12 mm distal diameter options

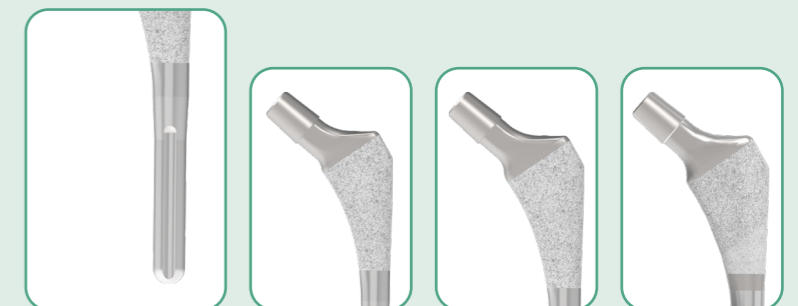

- 11 mm distal diameter is available in #2, #3 and #4 proximal size options

U2™ Revision Stem

Monoblock fully coated cylindrical revision stem

Shorter Neck Offset

- The U2 Revision Stem is designed with a shorter neck offset compared to primary implant designs in order to facilitate joint reduction for patients with soft tissue scarring or contracture from previous surgeries

U2 Revision Stem Offset Length

- 3~5 mm shorter than U2 hip stem

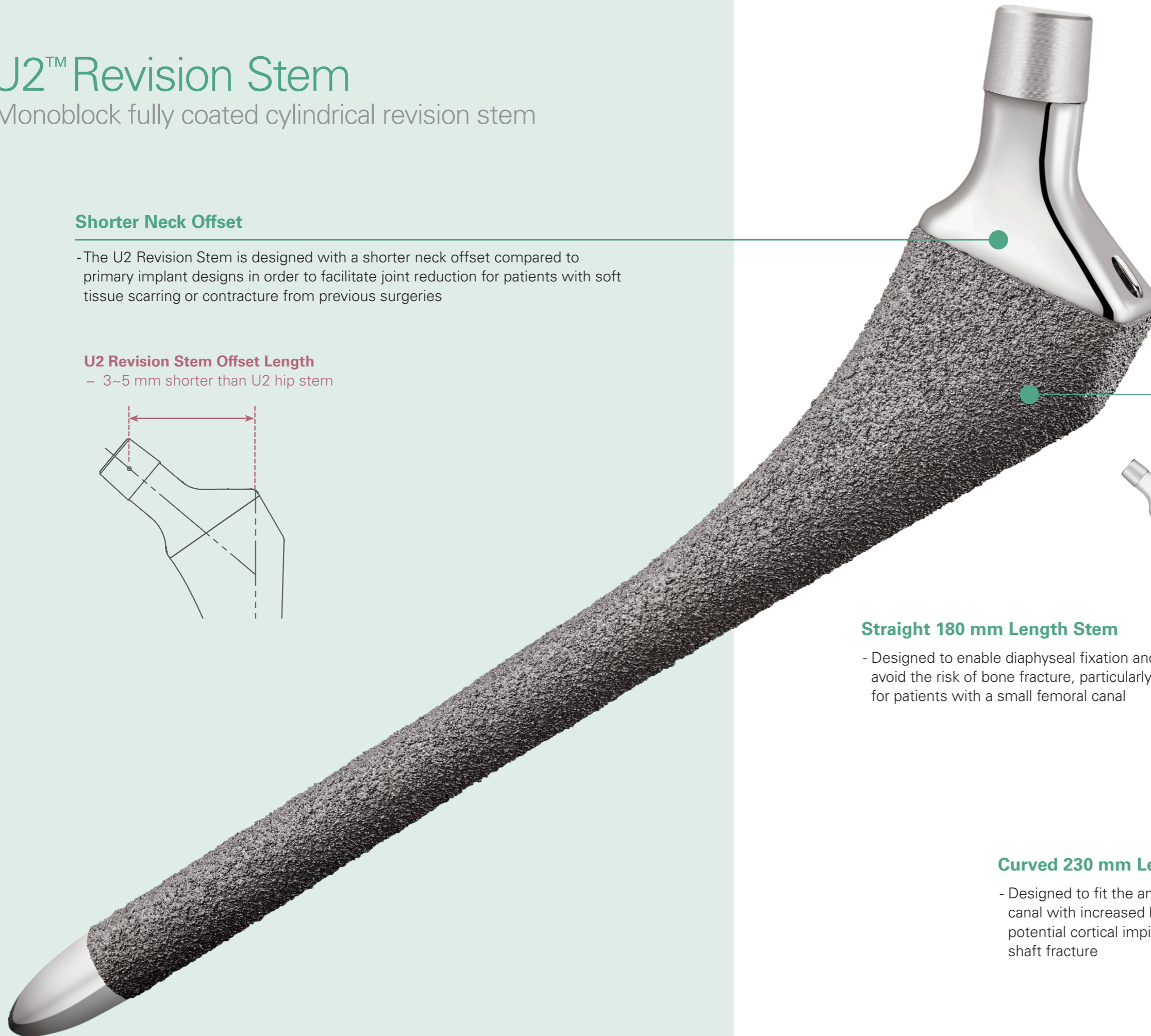
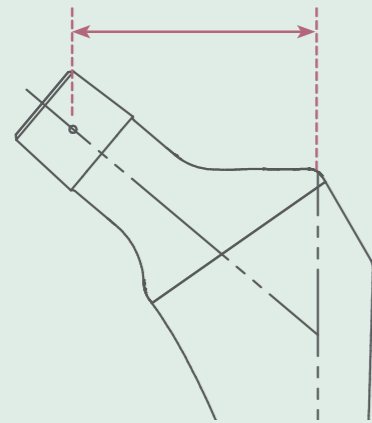

Fully Titanium-Plasma Spray Coating

- Designed to promote biological fixation

Straight 180 mm Length Stem

- Designed to enable diaphyseal fixation and avoid the risk of bone fracture, particularly for patients with a small femoral canal

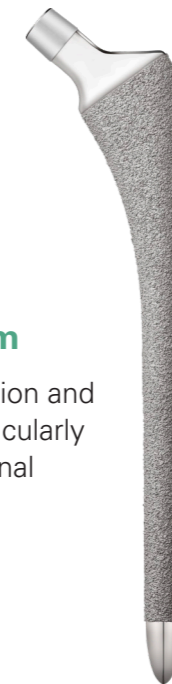

Curved 230 mm Length Stem

- Designed to fit the anatomical shape of a femoral canal with increased bone deficiency and prevent potential cortical impingement and intraoperative shaft fracture



Anterior Bowing

UCP™ Stem

Cemented comprehensive femoral solution for hip arthroplasty

The polished surface is designed to allow minimal friction at the stem-cement interface and reduce the potential for cement failure.

Adjustment Markers

- Assist the surgeon in adjusting insertion depth of the stem to help achieve optimal leg length

Standard stem (125 mm) length for primary cases
Long stem options in 180 mm, 210 mm, and 230 mm lengths for revision cases.

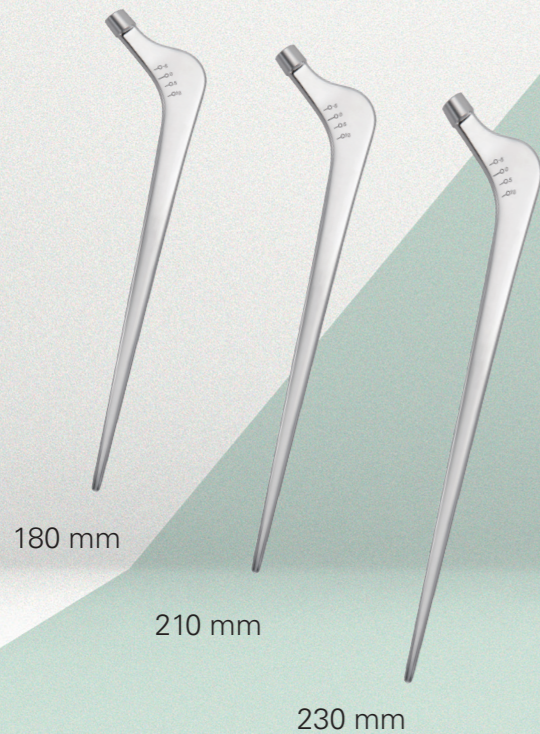

GTF II™ Stem

The GTF II Stem is a cemented stem indicated for patients with femoral head, neck and intertrochanteric fractures and severe proximal bone loss.

Multiple Sizing Options

- 2 stem lengths (130 mm and 160 mm)
- 2 stem diameters (Ø9 mm and Ø11 mm)
- 2 resection levels (45 mm and 55 mm)

Total 2 x 2 x 2 = 8 sizes

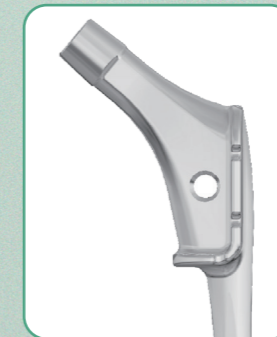

45 mm Resection Level

55 mm Resection Level

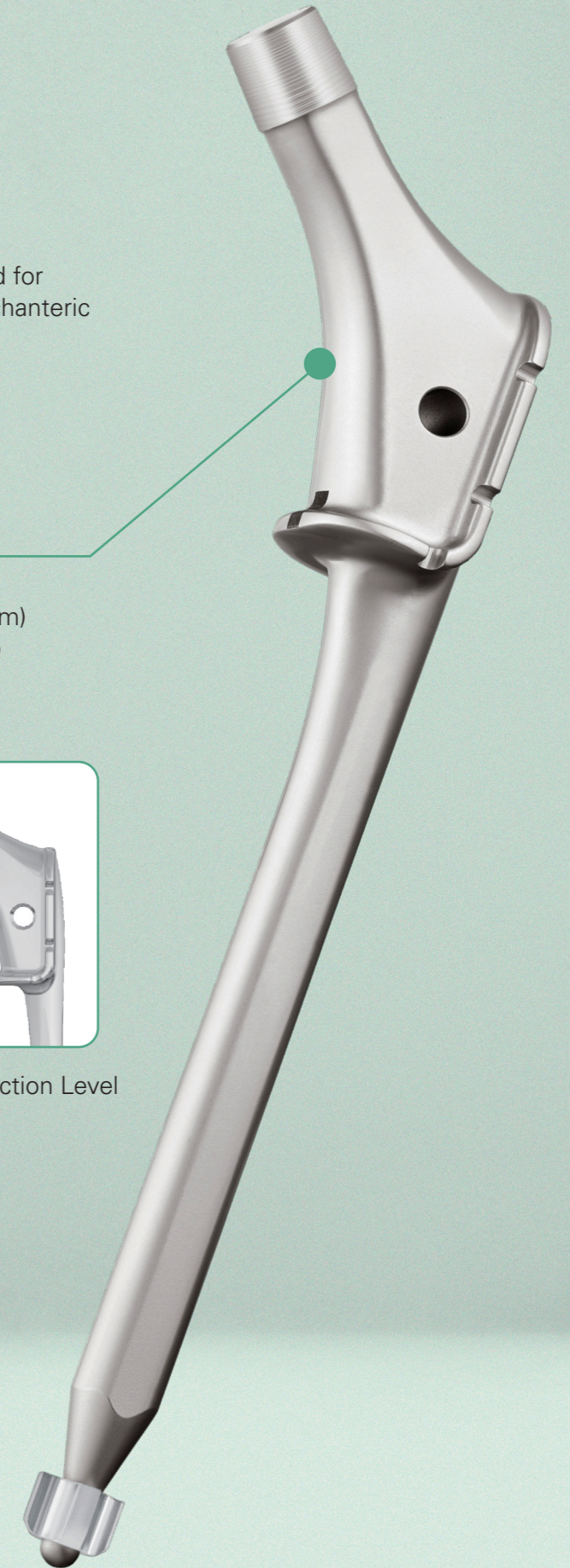

Locking Cage™

Acetabular reconstruction system

The Locking Cage acetabular revision system is designed to allow reconstruction of the acetabulum in patients with severe bone loss and pelvic discontinuity.



Modular Hook and Ischial Flange

- Designed to provide additional support and stability

Break the neck of Locking Nut, and leave the cap fully secured onto the Locking Cage

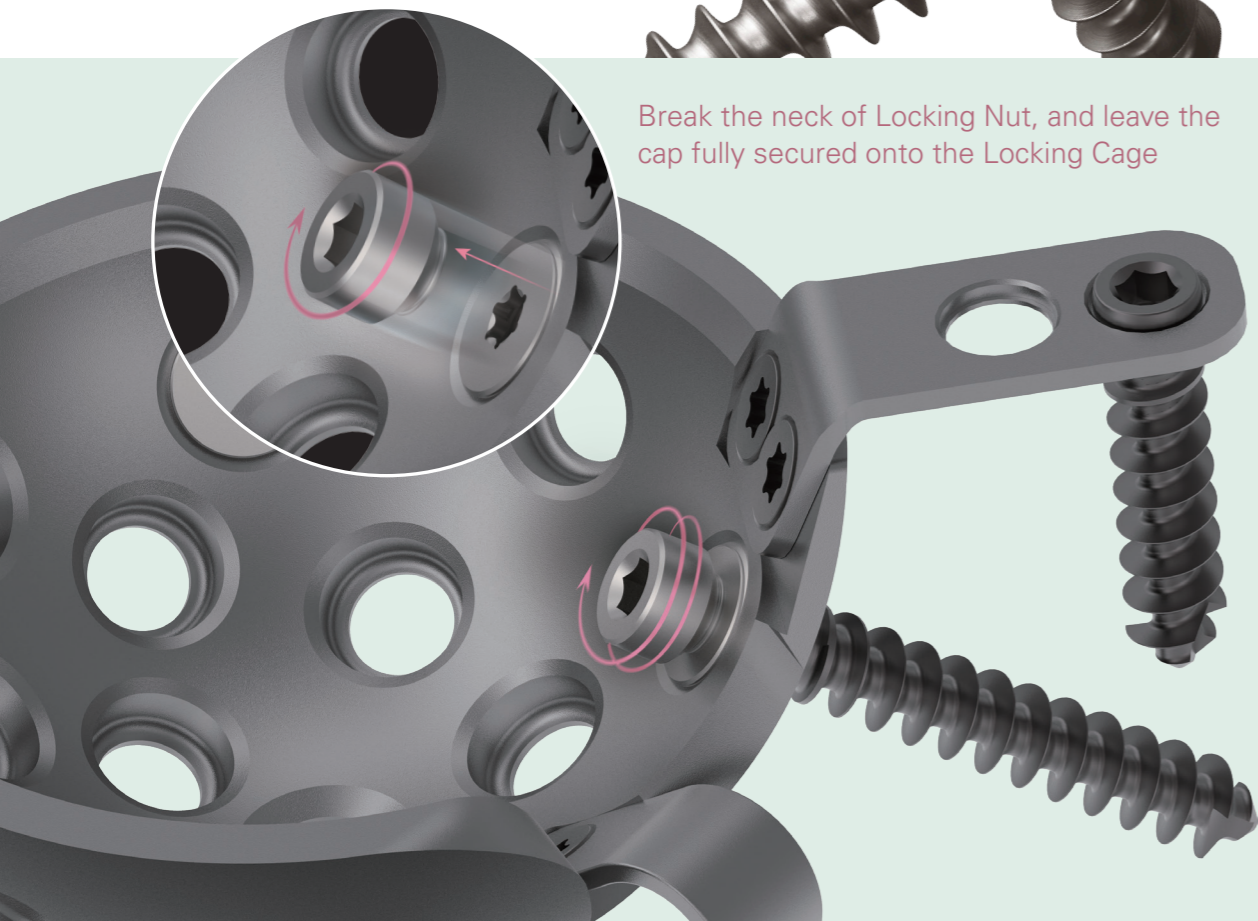

Locking Screw Design

The poly-axial bone screw is designed to provide flexibility selecting the optimal direction for screw insertion. In addition, the unique locking nut provides enhanced stability for the fixed structure by converting the compression screws into locking screws.



BIOLOX® OPTION

More OPTIONS for revision surgery

United Orthopedic BIOLOX® femoral heads and sleeves are designed specifically for use with United Orthopedic femoral stems.

Adaptor Sleeve for acetabular revision or femoral head exchange.

4 BIOLOX® *delta* head sizes are available:
28, 32, 36, 40 mm

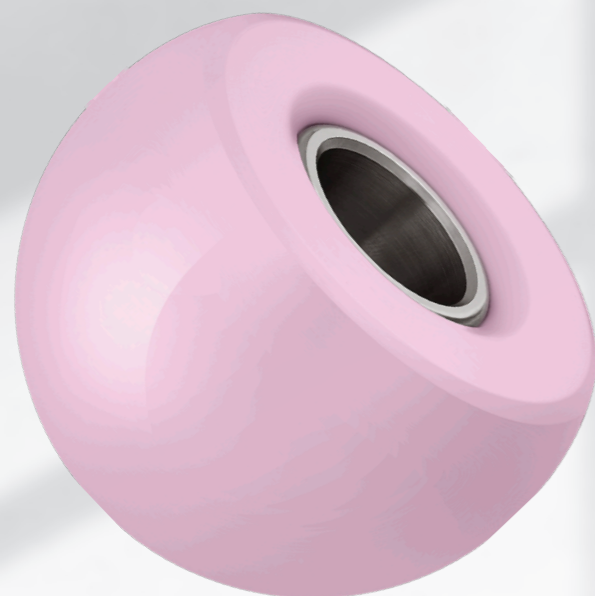
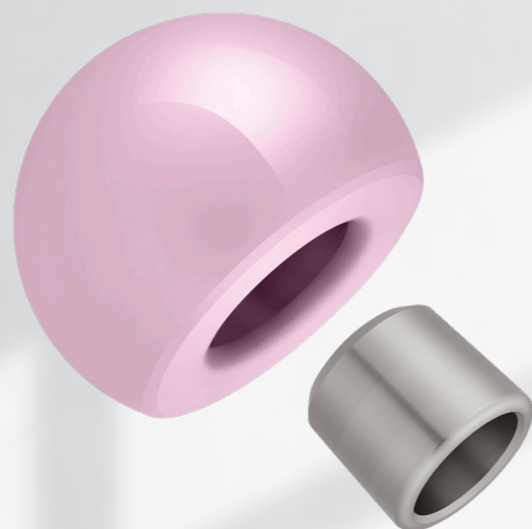

Titanium sleeves are available in 4 neck length:
S: -2 mm M: +1 mm L: +5 mm XL: +8 mm

*BIOLOX® is a registered trademark of the CeramTec Group, Germany

RepliCase™ Hip

Acetabular and femoral stem molding system

The RepliCase Hip is used for molding a temporary total hip prosthesis during surgery, and is intended to allow surgeons to model a temporary hip prosthesis in a simpler way.

Made of Medical Grade Silicone

- Allows for repeated autoclave cycles

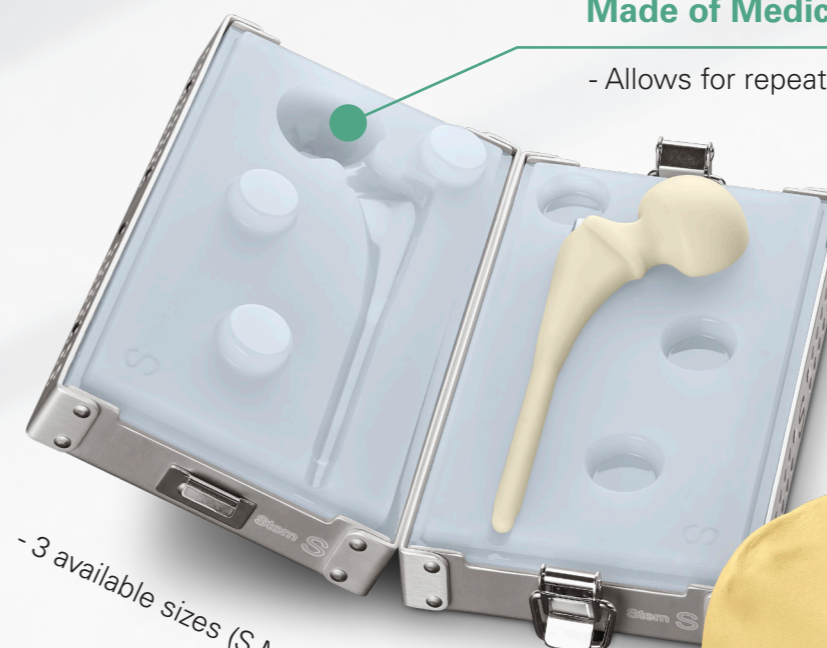

- 3 available sizes (S,M,L)

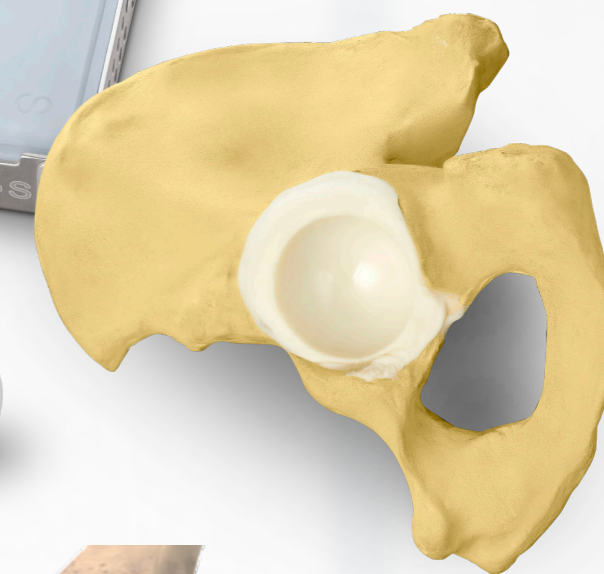

- 3 available sizes (S,M,L)



Reinforcement Rod

- Provides additional mechanical support



Implant – Acetabular Component

U-Motion II Cup System



No Hole



Cluster-Hole



Multi-Hole

Coating Surface	TPS / TPS with HA / TPS PLUS / TPS PLUS with HA
Sizes	44 mm ~ 70 mm

Liner



Standard

● XPE ● E-XPE



20° Lipped

● XPE ● E-XPE



BIOLOX® delta

Inner Diameter	28 / 32 / 36 / 40 mm	28 / 32 / 36 / 40 mm	28 / 32 / 36 / 40 mm
----------------	----------------------	----------------------	----------------------

Femoral Head

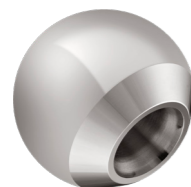

CoCr



BIOLOX® delta

Sizes	28 / 32 / 36 mm	28 / 32 / 36 / 40 mm
-------	-----------------	----------------------

Accessories



Cancellous Screw



Screw Hole Covers

Sizes	15 ~ 50 mm
-------	------------

Implant – Acetabular Component

UDM System



Press-fit



Peg-fixed



Cemented

Coating Surface	TPS PLUS / TPS PLUS with HA	TPS PLUS / TPS PLUS with HA	
Sizes	42 mm ~ 68 mm	42 mm ~ 68 mm	42 mm ~ 64 mm

Mobile Liner



● XPE ● E-XPE

Sizes	OD 42 mm ~ 68 mm	ID 22 / 28 mm
-------	------------------	---------------

Femoral Head

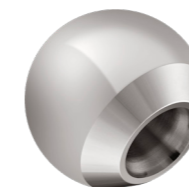

CoCr



BIOLOX® delta

Sizes	22* / 28 mm	28 mm
-------	-------------	-------

Accessories



Cobalt-chrome Cortical Screw

Sizes	25 ~ 65 mm
-------	------------

* The actual spherical diameter of a 22 mm metal head is 22.2 mm

Implant – Acetabular Component

Full XPE Cup



Full XPE Cup

Sizes 42 mm ~ 62 mm

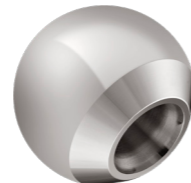

CoCr

Sizes 26 / 28 / 32 / 36 mm

Bipolar II Cap



Bipolar II Cap

Sizes 38 mm ~ 56 mm

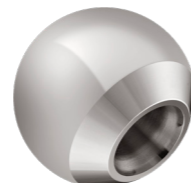

CoCr

Sizes 22* / 26 / 28 mm

BIOLOX® OPTION

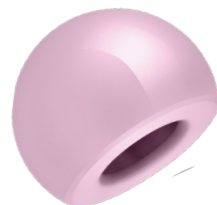

BIOLOX® delta

Sizes 28 / 32 / 36 / 40 mm



Neck Sleeve

Sizes S / M / L / XL

* The actual spherical diameter of a 22 mm metal head is 22.2 mm

Implant – Acetabular Component

Locking Cage



Cage

Sizes 50 mm ~ 70 mm



Hook

Sizes S / M / L



Ischial Flange

Single size



Screw

Sizes 15 mm ~ 75 mm



Locking Nut

Single size

RepliCase Hip



Cement Spacer Mold

Sizes S / M / L



Reinforcement Rod

Single size

Implant – Femoral Stem

Conformity Stem

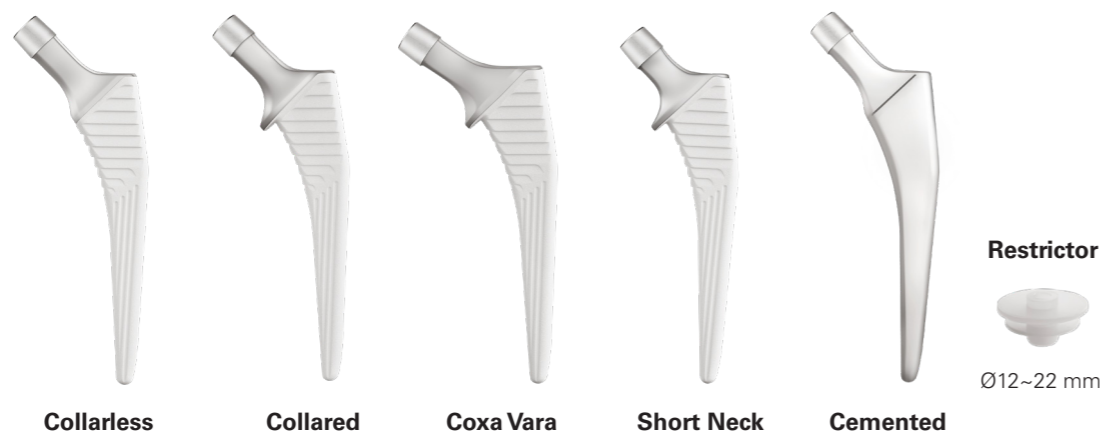

Standard Offset	# 1 ~ # 11	# 1 ~ # 11	# 2 ~ # 11	# 1 ~ # 3	# 1 ~ # 10
High Offset	# 1 ~ # 11	# 1 ~ # 11			# 1 ~ # 10

UTS Stem



Coating Surface	TPS	TPS with HA
Standard Offset	# 00 ~ # 14	# 00 ~ # 14
High Offset	# 1 ~ # 14	# 1 ~ # 14

UTF Reduced Stem



Standard Offset	# 00 ~ # 14
High Offset	# 0 ~ # 14

Implant – Femoral Stem

U2 Hip Stem

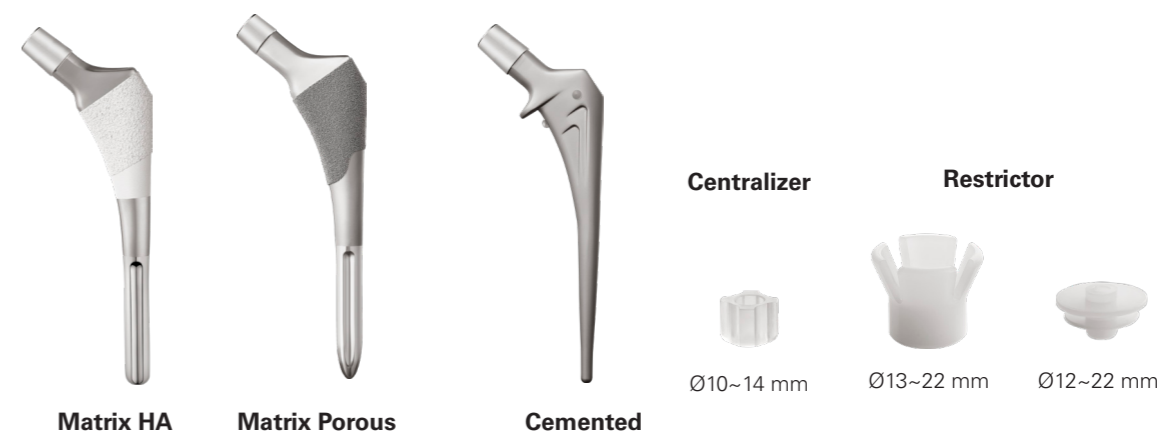

Proximal size	# 0 ~ # 7	# 1 ~ # 7	# 2 ~ # 6
Distal diameter	12 ~ 22 mm	12 ~ 22 mm	

U2 Revision Stem



Straight 180 mm / Ø11 ~ 18 mm Curved 230 mm / Ø11 ~ 18 mm (Left, Right)

UCP Stem

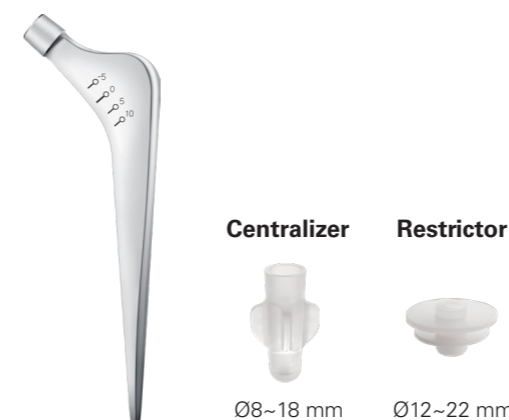

Stem Length : 125 mm	Long stem 180 mm : # 2 ~ # 3
Standard Offset : # 0 ~ # 5	Long stem 210 mm : # 3
High Offset : # 0 ~ # 5	Long stem 230 mm : # 3

GTF II Stem



Resection level 45, 55 mm
Distal diameter 9, 11 mm
Length 130, 160 mm

Please note that all United Orthopedic Corporation product brochures have been authored in the English language. Any translations into other languages have not been reviewed or approved by United Orthopedic Corporation and their accuracy cannot be confirmed. Any questions regarding United Orthopedic Corporation products should be directed to United Orthopedic Corporation at unitedorthopedic.com/contact.

The CE mark is valid only if it is also printed on the product label.
Not all products are approved by CE or FDA, please contact with your United representative or local distributor for further information.

