

Conformity™ Stem

Femoral Hip System



Surgical Technique Guide

Table of Contents

| | |
|---|----|
| Device Description | II |
| Surgical Overview | IV |
| Surgical Protocol | |
| Pre-operative Planning and Templating | 1 |
| A. Femoral Osteotomy | 2 |
| B. Femoral Canal Accessing | 3 |
| C. Canal Reaming | 4 |
| D. Lateralization | 5 |
| E. Canal Broaching | 6 |
| F. Calcar Preparation | 7 |
| G. Femoral Neck Templating | 8 |
| H. Trial Reduction | 10 |
| I. Stem Insertion | 11 |
| J. Stem Impaction | 12 |
| K. Femoral Head Impaction | 13 |
| Appendix | 14 |
| Order Information | 17 |

Device Description

Conformity Stem –

The Conformity stem platform provides a comprehensive stem solution to hip arthroplasty surgery. To provide surgeons with the implant that best meets the needs of their patient, Conformity features the clinical proven concepts of utilizing a fully hydroxyapatite (HA) coating on the stem, multiple neck options, collared and collarless features, and has 57 cementless options available. Additionally, 20 cemented options are available in standard and high offset collarless designs. Optimized dimensional parameters are applied to the stem design to maximize the biomechanical advantages and to facilitate minimally invasive surgery in Direct Anterior (DA) and non DA approaches.

77 stem options are available :

Cementless options

- Standard collared stem : size #1-11
- High offset collared stem : size #1-11
- Standard collarless stem : size #1-11
- High offset collarless stem : size #1-11
- Coxa Vara collared stem : size #2-11
- Short neck collared stem : size #1-3

Cemented options

- Standard collarless stem : size #1-10
- High offset collarless stem : size #1-10

INDICATIONS

The device is indicated for use in hip arthroplasty in skeletally mature patients with the following conditions:

1. A severely painful and/or disabled joint from osteoarthritis, traumatic arthritis, rheumatoid arthritis, or congenital hip dysplasia.
2. Avascular necrosis of the femoral head.
3. Acute traumatic fracture of the femoral head or neck.
4. Failed previous hip surgery including joint reconstruction, internal fixation, arthrodesis, hemiarthroplasty, surface replacement or total hip replacement.
5. Certain cases of ankylosis.

Please note, this Surgical Protocol is consistent with our validated labeling. It is not intended to substitute for each surgeon's individual medical judgement regarding patient care. It is intended to be a reference document to be utilized in support of total hip arthroplasty using United Orthopedics' Conformity stem.



Surgical Overview

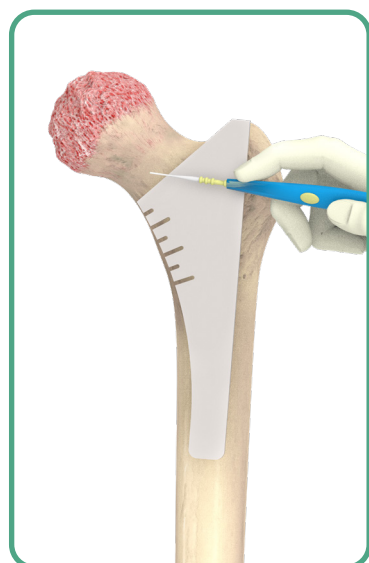

A. Femoral Osteotomy

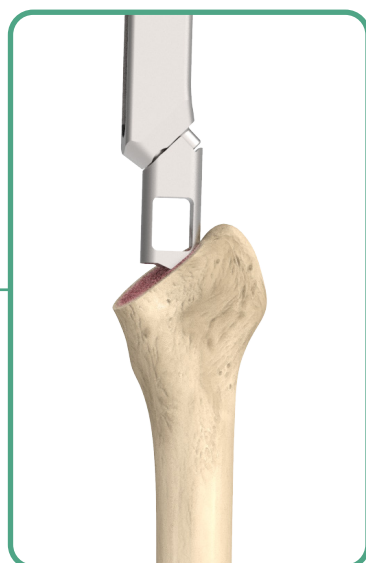

B. Femoral Canal Accessing

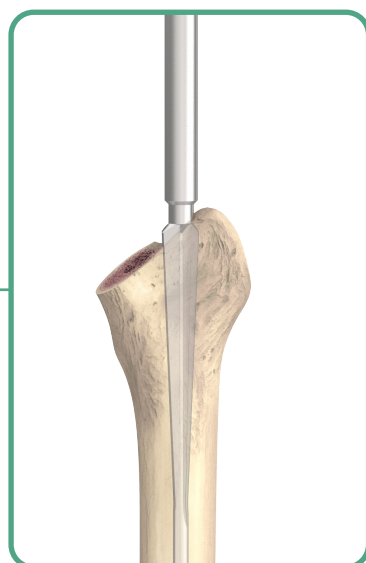

C. Canal Reaming



D. Lateralization

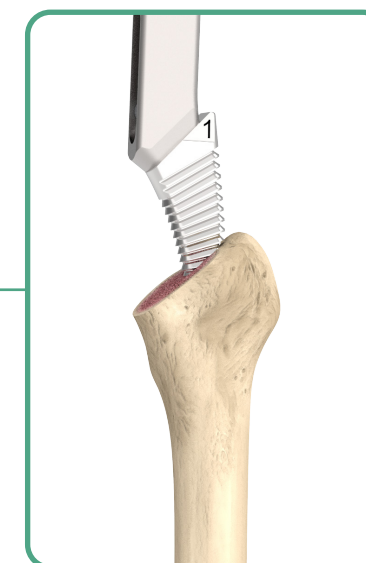

E. Canal Broaching



F. Calcar Preparation

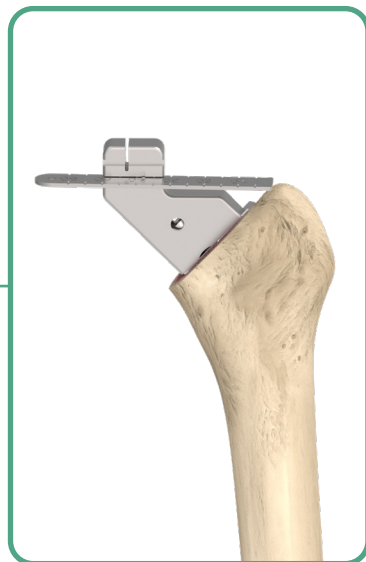

G. Femoral Neck Templating



H. Trial Reduction

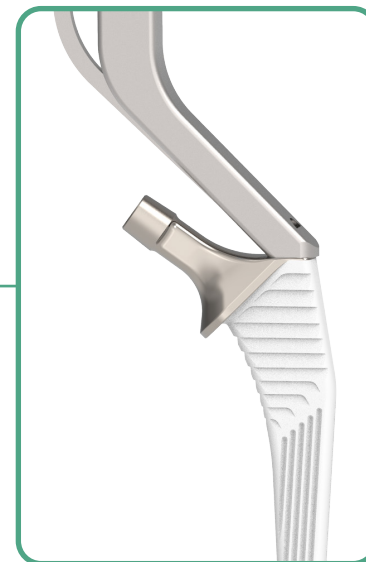

I. Stem Insertion

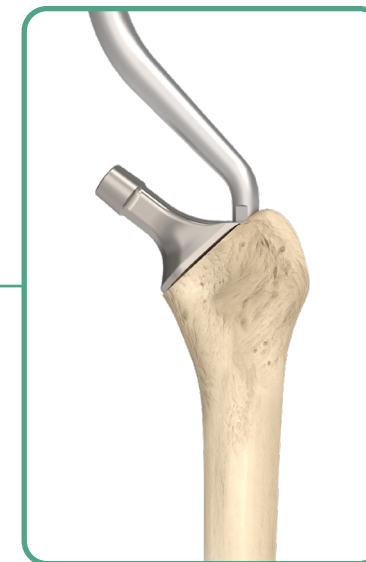

J. Stem Impaction

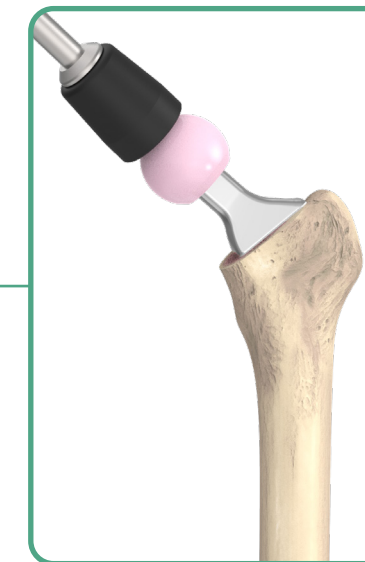

K. Femoral Head Impaction

Preoperative Planning and Templating

Preoperative planning is essential for determining the optimal stem size, neck resection level and the appropriate neck length. Making an accurate femoral component selection begins with thorough radiographic evaluation of the affected femur, both A/P view and lateral view. The A/P radiographic image should include bilateral hip joints to help evaluate the affected side. These radiographs provide an estimation of leg length discrepancy, femoral offset and center of rotation needed to reconstruct hip biomechanics.

The conformity stem features a medial step and horizontal / vertical grooves for stabilization. The stem is designed to seat in cancellous bone. When templating, the engagement of the implant template with the cortical bone should be avoided. Sparing around 1 mm of space between the stem implant and the cortex of proximal femur is recommended. Standard and high offset options are available. It is recommended to pre-operatively template the prosthesis size that best fits the metaphysis canal area. Templates show the neck length and offset for each of the head/ neck combinations (-3 to +10 mm, depending on head material and diameter). The final determination of implant choice should take into account the acetabular cup position, cup size, and hip center.

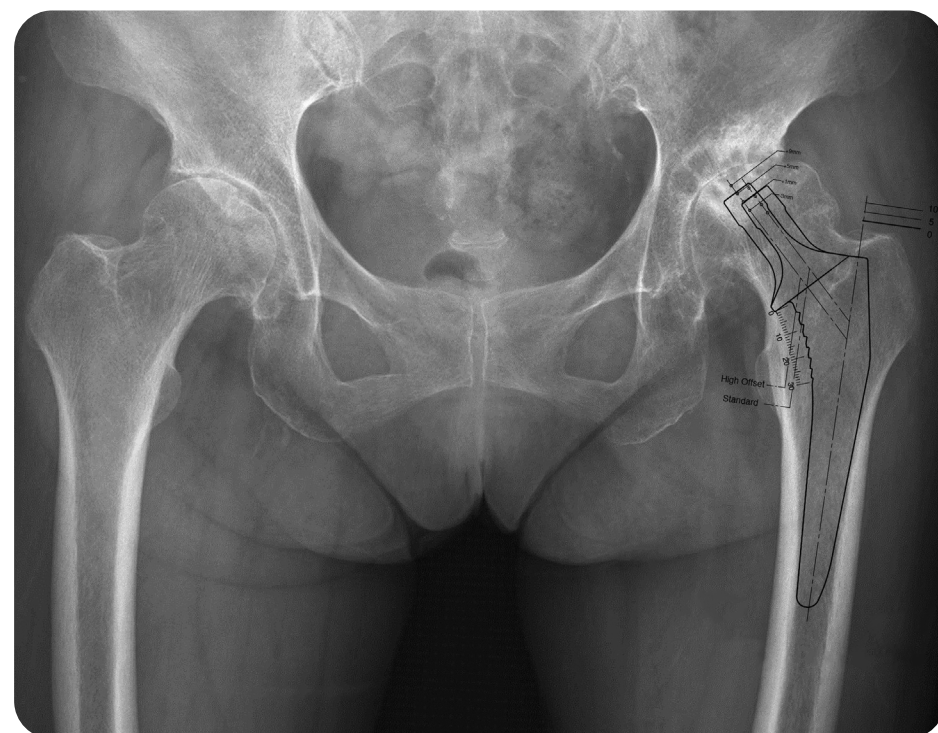

A. Femoral Osteotomy

During preoperative templating, determine the neck resection level by referencing the distance above the lesser trochanter (about 10-15 mm)

Intra-operatively, align the **Conformity Neck Resection Guide** with the anatomical axis of the femoral canal. Mark the cut line using electrocautery, then complete the femoral neck resection with a power saw. Connect the **Femoral Head Extractor** with **Modular T-Handle** or power tool then remove the femoral head.

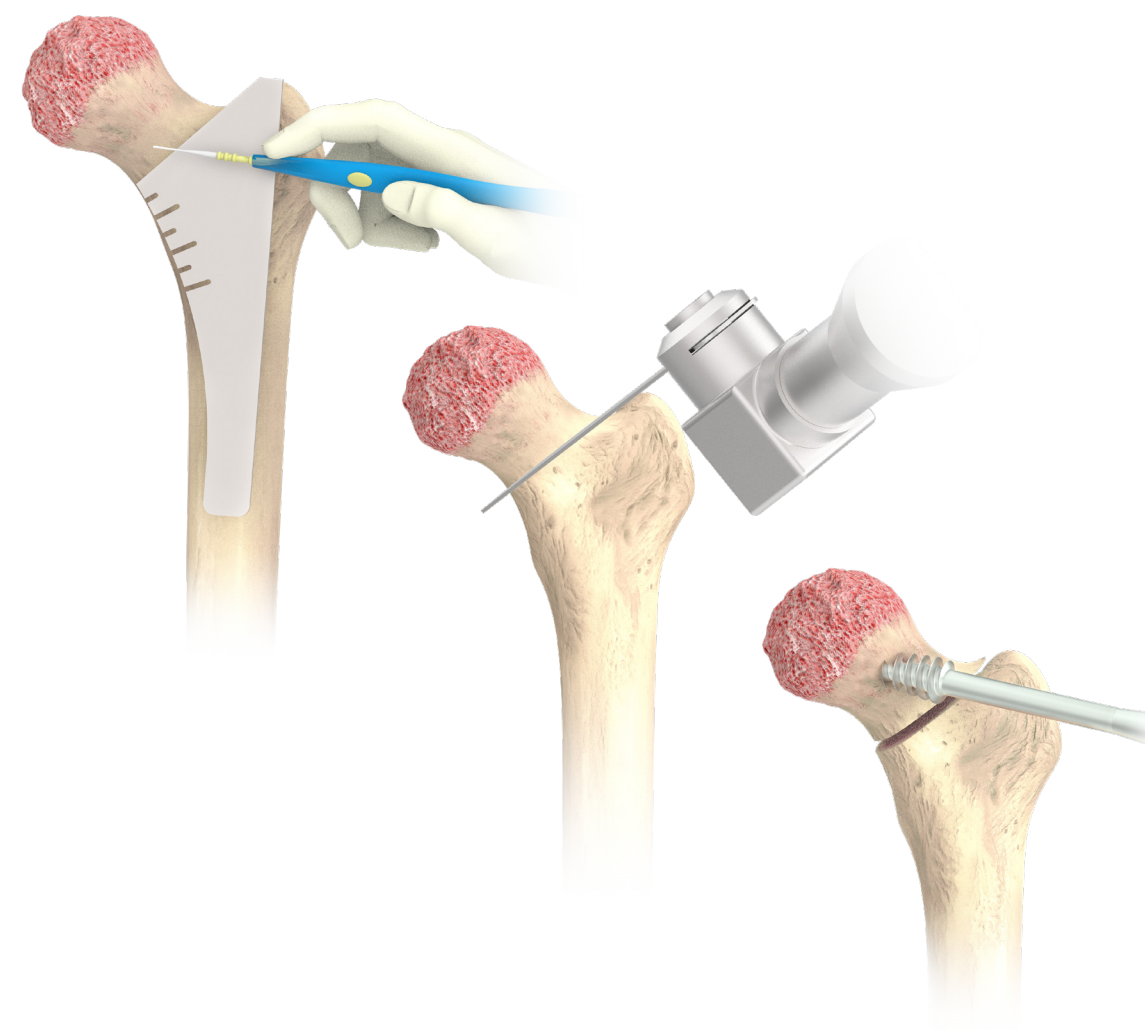

Instruments



Conformity Neck Resection Guide



Modular T-Handle



Femoral Head Extractor

B. Femoral Canal Accessing

Utilize the modular **Femoral Cutting Chisel** with **Broach Handle** for adequate lateral/posterior piriformis fossa initial entry into femoral canal.



Instruments



Modular Femoral Cutting Chisel



Straight Broach Handle



Offset Broach Handle



Dual Offset Broach Handle

C. Canal Reaming

The **Starter Reamer** is used with the **Modular T-Handle** or power tool to open the femoral canal and to help ensure the correct reamer alignment within the femoral anatomical axis.

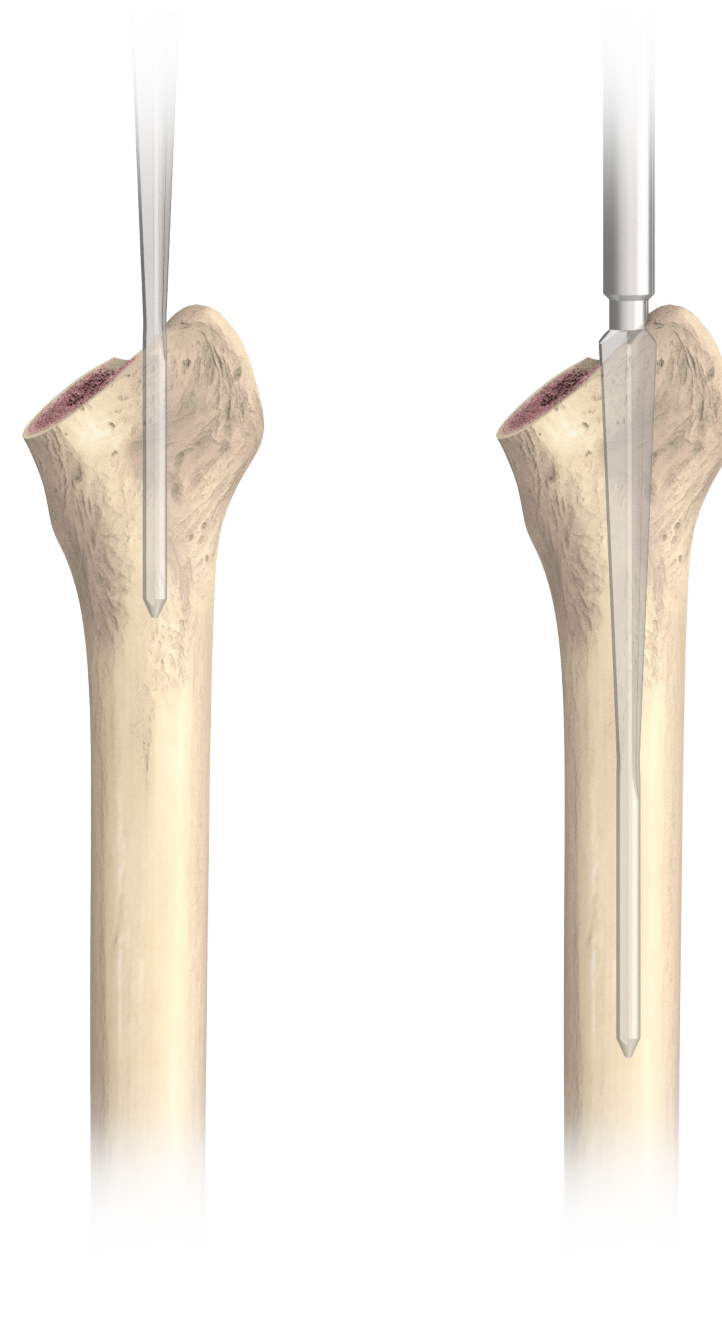

Instruments



Modular T-Handle



Starter Reamer

D. Lateralization

Appropriate lateralization of the canal entry when needed is important to prevent medial shift alignment of the prosthetic stem during insertion. Utilize the **Canal Finder Rasp** manually to enlarge the canal laterally beneath the greater trochanter. This step helps to guide the axis of the femur for subsequent broaching and stem implantation.

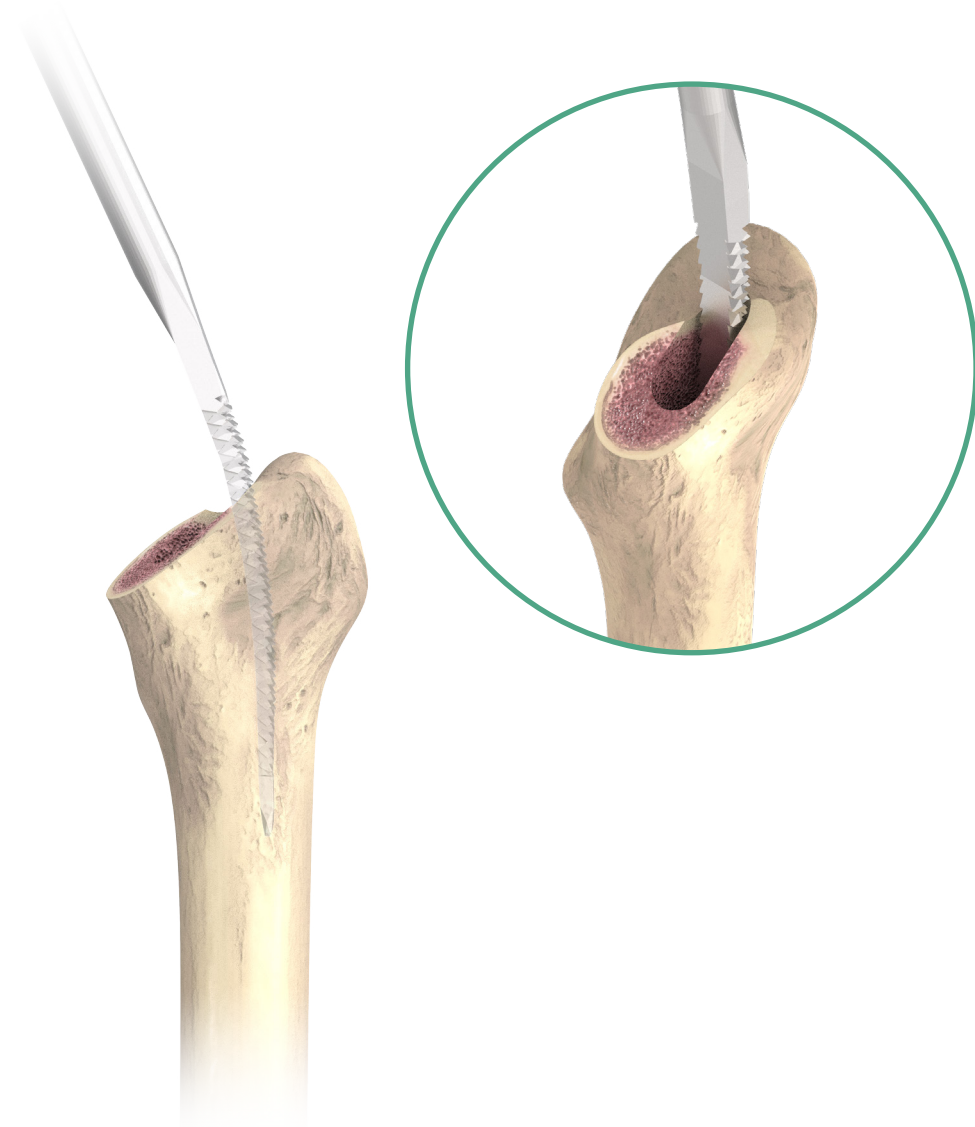

Instruments



Canal Finder Rasp

E. Canal Broaching

Carefully control the direction for ideal anteversion. Gradually enlarge the canal with the **Conformity Broach** along the created orientation until the planned template size is achieved. The M/L dimensions of the **Conformity Broach** are identical to that of the implant. There is a 0.75 mm difference on each side of broach between sizes (#1-#2, 0.375 mm).

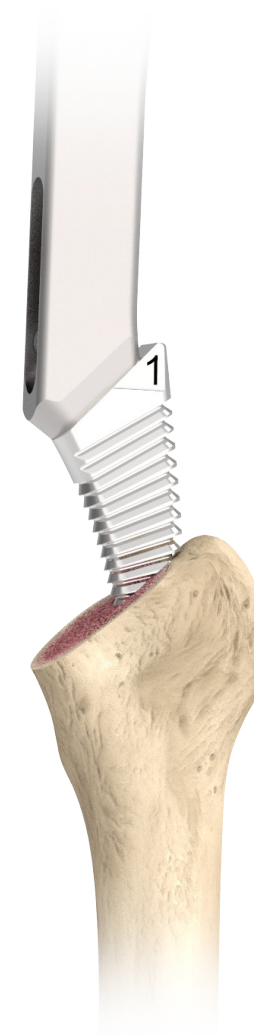

Instruments



Conformity Broach



Straight Broach Handle



Offset Broach Handle



Dual Offset Broach Handle

F. Calcar Preparation

When the final broach is seated, choose the corresponding **Conformity Calcar Reamer** and guide the reamer over the **Conformity Broach** trunnion ensuring that the **Conformity Calcar Reamer** is axially aligned with the trunnion and is stable.

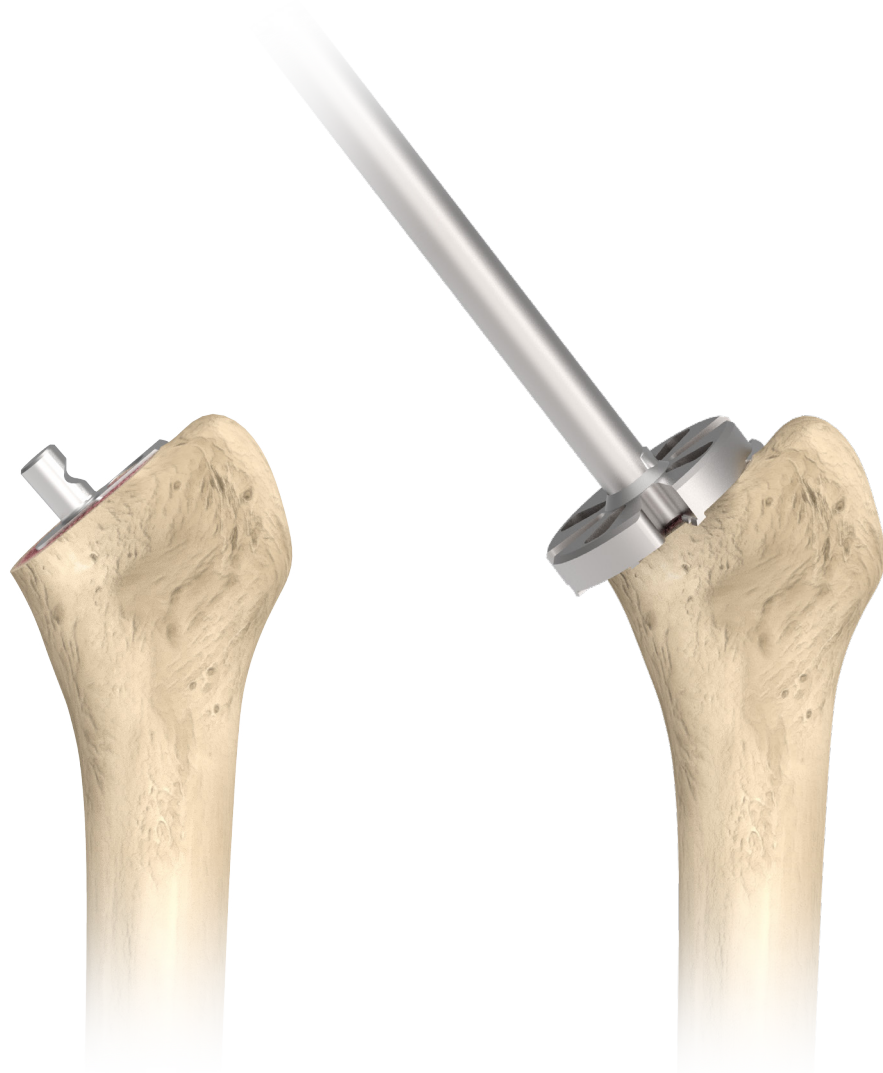

Instruments



Conformity Broach



Calcar Reamer
(small, large)

(Optional) G. Femoral Neck Templating

This **Neck Template** is prepared for intra-operative confirmation before a neck trial is selected.

The ideal horizontal offset of the femoral head can be evaluated preoperatively, by using radiographs and templates. The grooves on the **Neck Template** represent the suggested neck type for the stem. Each intersection location shows the exact head center when choosing the corresponding stem:

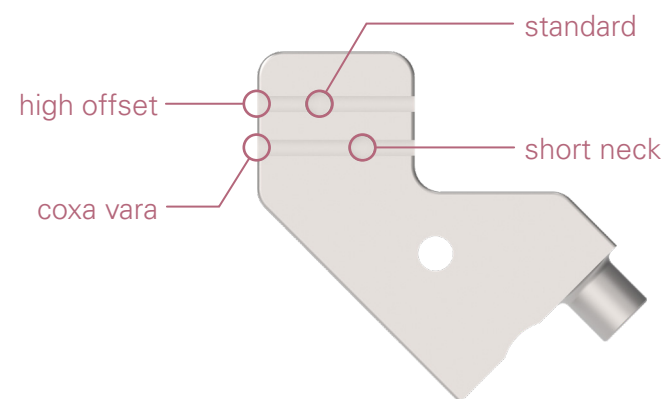

Put the **Neck Template** onto the trunnion of the **Conformity Broach**. Place the **Neck Template Ruler** into the appropriate groove on the **Neck Template**. The apex of the greater trochanter may be used as a reference for the height of the head center. If the expected head location is matched to one of the groove intersections, then choose the corresponding neck type stem with +0 femoral head to reconstruct the head center.

Instruments



Conformity Broach



Neck Template



Neck Template Ruler

(Optional) G. Femoral Neck Templating

If a pre-operative plan is made and the horizontal offset is determined, or an intra-operative measurement gives a suggested offset which is not equal to the defined neck type, surgeons may read the marks on the **Neck Template Ruler**, and decide the optimal offset required for restoring joint stability.

To achieve the desired offset, surgeons will need to use head offset as required. However, change in leg length should be considered. The following table shows the combination of different Conformity stem neck types to various head offset offered :

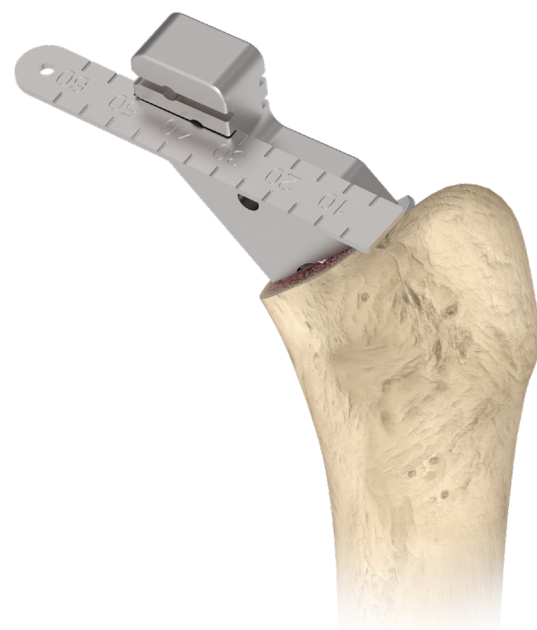

Instruments



Conformity Broach



Neck Template



Neck Template Ruler

(Optional) G. Femoral Neck Templating

| Head Size | CoCr 28 / 32 / 36 mm | | | | | | Ceramic 28 mm | | | Ceramic 32 mm | | | | Ceramic 36 / 40 mm | | | |
|-----------|-------------------------|----|------|----|------|-----|------------------|----|----|------------------|----|----|----|-----------------------|----|----|----|
| | -3 | +0 | +2.5 | +5 | +7.5 | +10 | -2.5 | +1 | +4 | -3 | +1 | +5 | +8 | -3 | +1 | +5 | +9 |

| Standard (#1-#11) | #1 | 33.9 | 36.0 | 37.8 | 39.5 | 41.3 | 43.1 | 34.2 | 36.7 | 38.8 | 33.9 | 36.7 | 39.5 | 41.7 | 33.9 | 36.7 | 39.5 | 42.4 |
|----------------------|-----|------|------|------|------|------|------|------|------|------|------|------|------|------|------|------|------|------|
| | #2 | 34.4 | 36.5 | 38.3 | 40.0 | 41.8 | 43.6 | 34.7 | 37.2 | 39.3 | 34.4 | 37.2 | 40.0 | 42.2 | 34.4 | 37.2 | 40.0 | 42.9 |
| | #3 | 35.4 | 37.5 | 39.3 | 41.0 | 42.8 | 44.6 | 35.7 | 38.2 | 40.3 | 35.4 | 38.2 | 41.0 | 43.2 | 35.4 | 38.2 | 41.0 | 43.9 |
| | #4 | 35.9 | 38.0 | 39.8 | 41.5 | 43.3 | 45.1 | 36.2 | 38.7 | 40.8 | 35.9 | 38.7 | 41.5 | 43.7 | 35.9 | 38.7 | 41.5 | 44.4 |
| | #5 | 36.9 | 39.0 | 40.8 | 42.5 | 44.3 | 46.1 | 37.2 | 39.7 | 41.8 | 36.9 | 39.7 | 42.5 | 44.7 | 36.9 | 39.7 | 42.5 | 45.4 |
| | #6 | 37.4 | 39.5 | 41.3 | 43.0 | 44.8 | 46.6 | 37.7 | 40.2 | 42.3 | 37.4 | 40.2 | 43.0 | 45.2 | 37.4 | 40.2 | 43.0 | 45.9 |
| | #7 | 37.9 | 40.0 | 41.8 | 43.5 | 45.3 | 47.1 | 38.2 | 40.7 | 42.8 | 37.9 | 40.7 | 43.5 | 45.7 | 37.9 | 40.7 | 43.5 | 46.4 |
| | #8 | 38.9 | 41.0 | 42.8 | 44.5 | 46.3 | 48.1 | 39.2 | 41.7 | 43.8 | 38.9 | 41.7 | 44.5 | 46.7 | 38.9 | 41.7 | 44.5 | 47.4 |
| | #9 | 39.4 | 41.5 | 43.3 | 45.0 | 46.8 | 48.6 | 39.7 | 42.2 | 44.3 | 39.4 | 42.2 | 45.0 | 47.2 | 39.4 | 42.2 | 45.0 | 47.9 |
| | #10 | 40.4 | 42.5 | 44.3 | 46.0 | 47.8 | 49.6 | 40.7 | 43.2 | 45.3 | 40.4 | 43.2 | 46.0 | 48.2 | 40.4 | 43.2 | 46.0 | 48.9 |
| | #11 | 41.4 | 43.5 | 45.3 | 47.0 | 48.8 | 50.6 | 41.7 | 44.2 | 46.3 | 41.4 | 44.2 | 47.0 | 49.2 | 41.4 | 44.2 | 47.0 | 49.9 |

| High Offset (#1-#11) Coxa Vara (#2-#11) | #1 | 40.9 | 43.0 | 44.8 | 46.5 | 48.3 | 50.1 | 41.2 | 43.7 | 45.8 | 40.9 | 43.7 | 46.5 | 48.7 | 40.9 | 43.7 | 46.5 | 49.4 |
|--|-----|------|------|------|------|------|------|------|------|------|------|------|------|------|------|------|------|------|
| | #2 | 41.4 | 43.5 | 45.3 | 47.0 | 48.8 | 50.6 | 41.7 | 44.2 | 46.3 | 41.4 | 44.2 | 47.0 | 49.2 | 41.4 | 44.2 | 47.0 | 49.9 |
| | #3 | 42.4 | 44.5 | 46.3 | 48.0 | 49.8 | 51.6 | 42.7 | 45.2 | 47.3 | 42.4 | 45.2 | 48.0 | 50.2 | 42.4 | 45.2 | 48.0 | 50.9 |
| | #4 | 42.9 | 45.0 | 46.8 | 48.5 | 50.3 | 52.1 | 43.2 | 45.7 | 47.8 | 42.9 | 45.7 | 48.5 | 50.7 | 42.9 | 45.7 | 48.5 | 51.4 |
| | #5 | 43.9 | 46.0 | 47.8 | 49.5 | 51.3 | 53.1 | 44.2 | 46.7 | 48.8 | 43.9 | 46.7 | 49.5 | 51.7 | 43.9 | 46.7 | 49.5 | 52.4 |
| | #6 | 44.4 | 46.5 | 48.3 | 50.0 | 51.8 | 53.6 | 44.7 | 47.2 | 49.3 | 44.4 | 47.2 | 50.0 | 52.2 | 44.4 | 47.2 | 50.0 | 52.9 |
| | #7 | 44.9 | 47.0 | 48.8 | 50.5 | 52.3 | 54.1 | 45.2 | 47.7 | 49.8 | 44.9 | 47.7 | 50.5 | 52.7 | 44.9 | 47.7 | 50.5 | 53.4 |
| | #8 | 45.9 | 48.0 | 49.8 | 51.5 | 53.3 | 55.1 | 46.2 | 48.7 | 50.8 | 45.9 | 48.7 | 51.5 | 53.7 | 45.9 | 48.7 | 51.5 | 54.4 |
| | #9 | 46.4 | 48.5 | 50.3 | 52.0 | 53.8 | 55.6 | 46.7 | 49.2 | 51.3 | 46.4 | 49.2 | 52.0 | 54.2 | 46.4 | 49.2 | 52.0 | 54.9 |
| | #10 | 47.4 | 49.5 | 51.3 | 53.0 | 54.8 | 56.6 | 47.7 | 50.2 | 52.3 | 47.4 | 50.2 | 53.0 | 55.2 | 47.4 | 50.2 | 53.0 | 55.9 |
| | #11 | 48.4 | 50.5 | 52.3 | 54.0 | 55.8 | 57.6 | 48.7 | 51.2 | 53.3 | 48.4 | 51.2 | 54.0 | 56.2 | 48.4 | 51.2 | 54.0 | 56.9 |

| Short Neck (#1-#3) | #1 | 28.9 | 31.0 | 32.8 | 34.5 | 36.3 | 38.1 | 29.2 | 31.7 | 33.8 | 28.9 | 31.7 | 34.5 | 36.7 | 28.9 | 31.7 | 34.5 | 37.4 |
|-----------------------|----|------|------|------|------|------|------|------|------|------|------|------|------|------|------|------|------|------|
| | #2 | 29.4 | 31.5 | 33.3 | 35.0 | 36.8 | 38.6 | 29.7 | 32.2 | 34.3 | 29.4 | 32.2 | 35.0 | 37.2 | 29.4 | 32.2 | 35.0 | 37.9 |
| | #3 | 30.4 | 32.5 | 34.3 | 36.0 | 37.8 | 39.6 | 30.7 | 33.2 | 35.3 | 30.4 | 33.2 | 36.0 | 38.2 | 30.4 | 33.2 | 36.0 | 38.9 |

Unit : mm

H. Trial Reduction

Assemble the corresponding **Conformity Neck Trial** (standard, high offset, coxa vara, or short neck) onto the broach. Perform the trial reduction using the **Femoral Head Trial** with the desired diameter and neck length. Any correction of selected implant size can be made during the reassessment of leg length and joint biomechanics if required.



Instruments



I. Stem Insertion

After trial reduction, remove the broach and introduce the stem by using the **Quick Connect Holder**. Use the holder to firmly attach the stem via the insertion hole on the stem shoulder.

Gently tap the holder to achieve initial stem implantation into the medullary canal. Proper care should be taken to orient the stem with proper alignment and version.

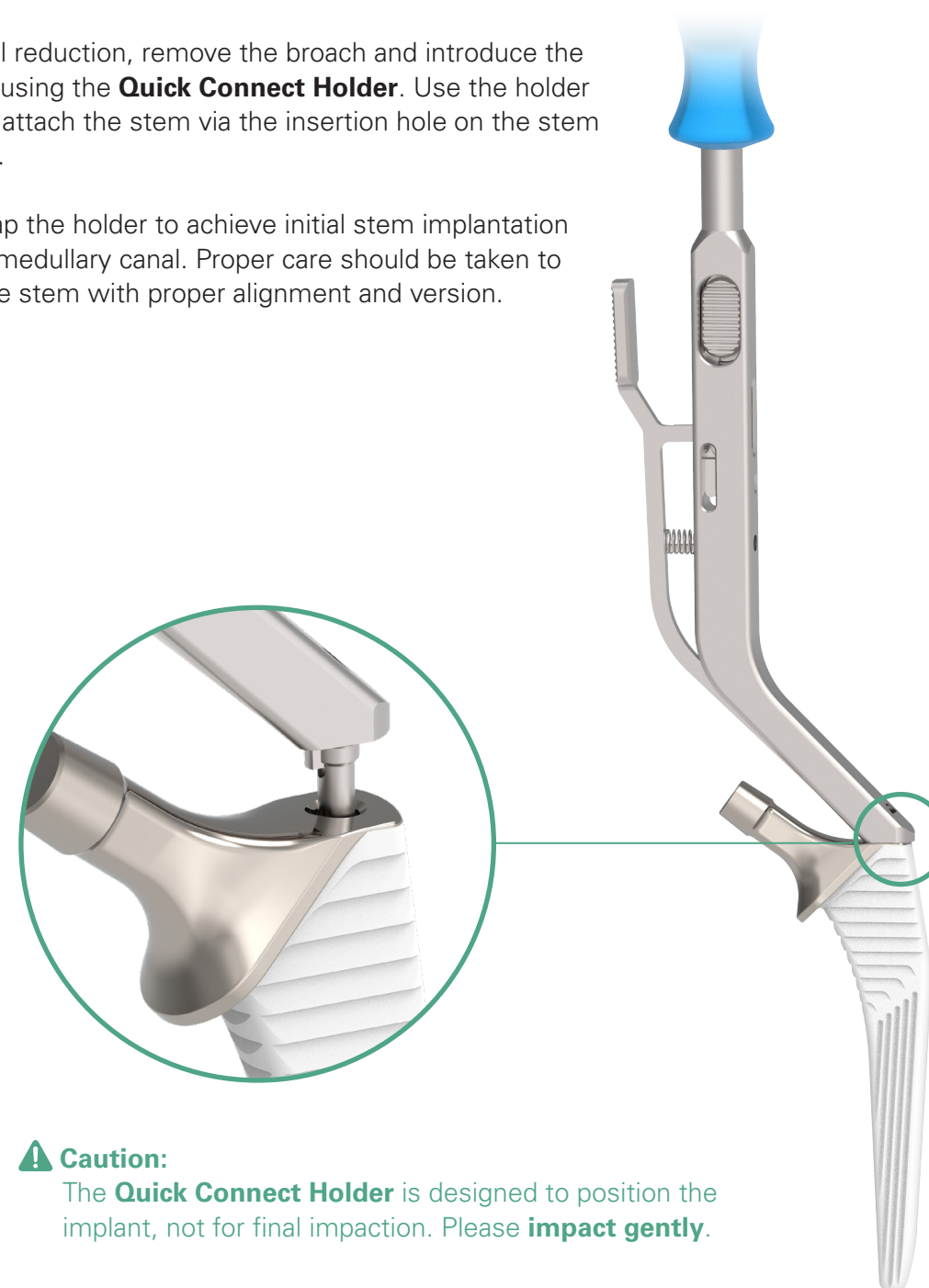

⚠ Caution:
The **Quick Connect Holder** is designed to position the implant, not for final impaction. Please **impact gently**.

Instruments

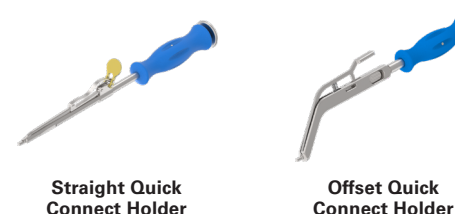

J. Stem Impaction

Use **Straight** or **Curved Stem Impactors** to further advance the stem into the canal. The prosthesis should be seated until the most proximal portion of the coating surface is in line with the neck resection level.

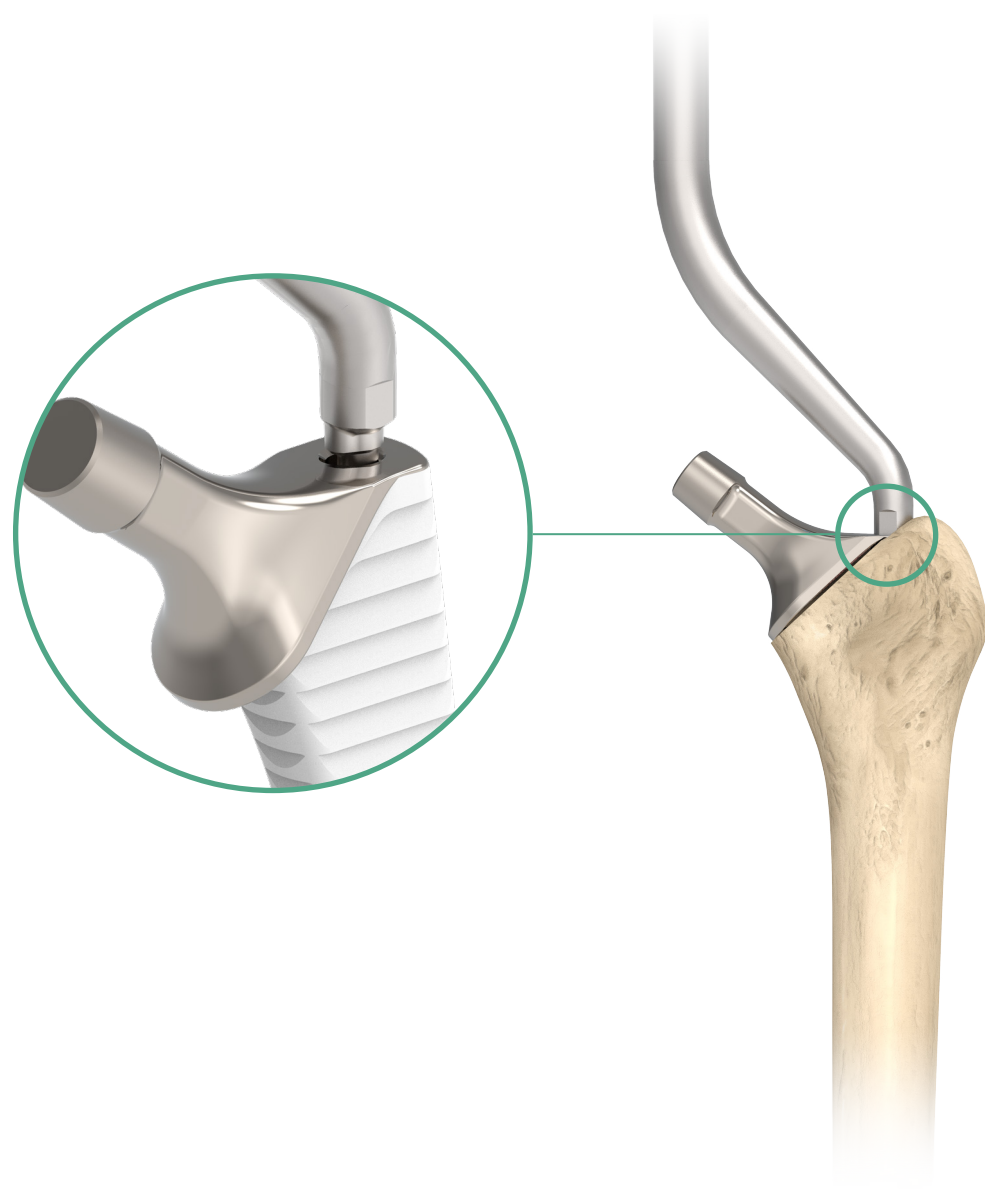

Instruments

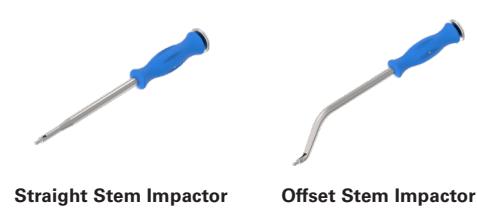

Straight Stem Impactor

Offset Stem Impactor

K. Femoral Head Impaction

Perform a final trial reduction to confirm stability and leg length by using the **Femoral Head Trials**. After the appropriate femoral head size has been determined, place it onto the cleaned and dried taper by twisting it on by hand.

Connect the **Femoral Head Impactor** and **Universal Handle** and moderately impact the femoral head until it is firmly seated. Clean the bearing surface then reduce the hip with the **Pusher**.

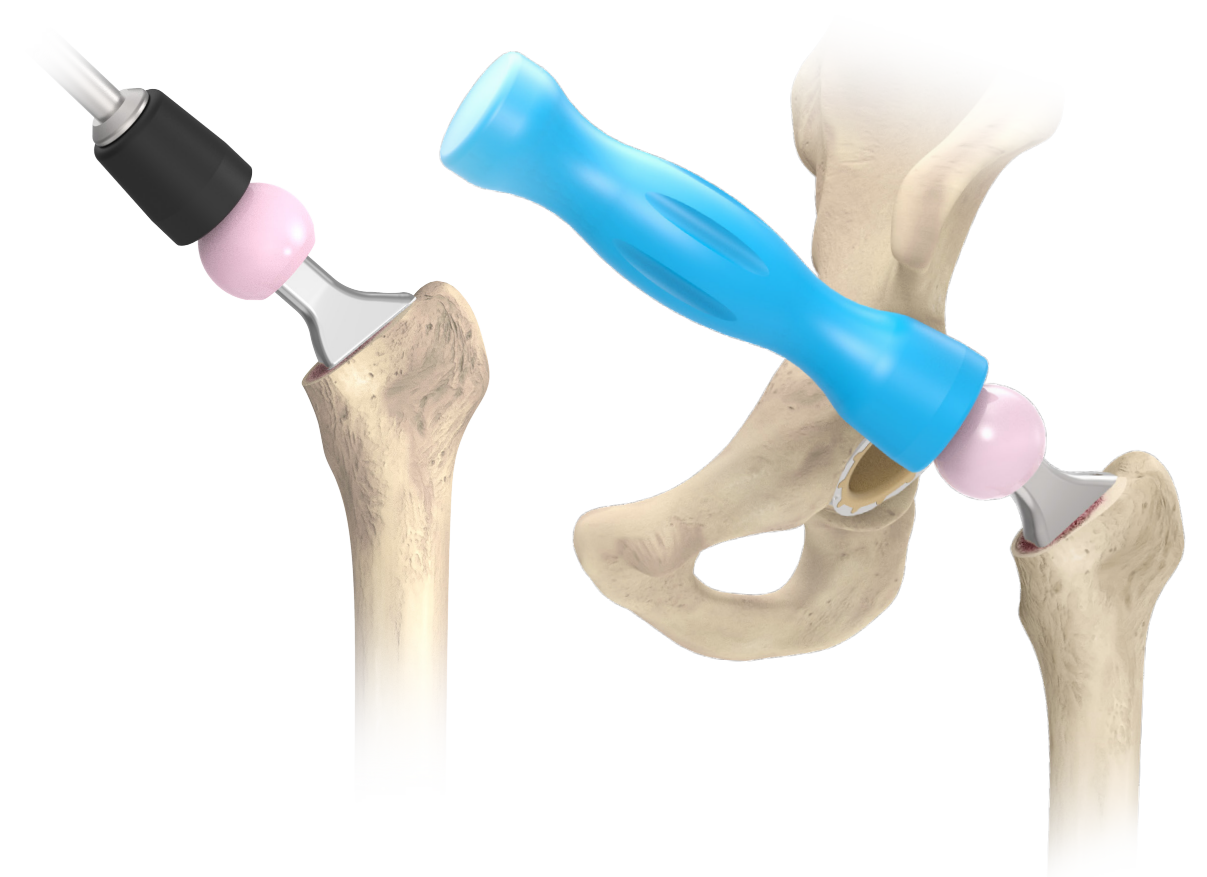

Instruments

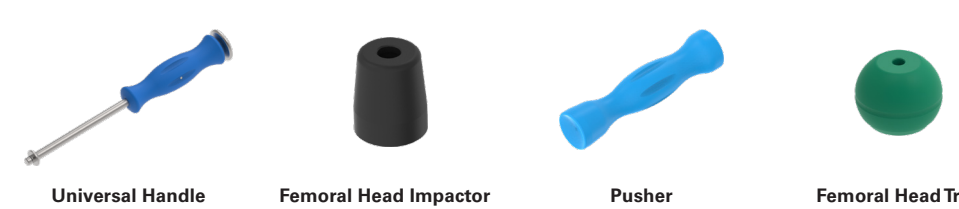

Universal Handle

Femoral Head Impactor

Pusher

Femoral Head Trial

Appendix

Femoral Canal Sizing (Cemented Stem Only)

If patients' condition is not suitable for inserting a cementless Conformity stem, then the optional cemented stem can be used. Assemble the **Modular T-handle, Restrictor Inserter**, and the appropriate **Canal Sizer**. Insert the assembly into the femoral canal to evaluate the canal size. Depth of insertion should depend on the designated size (read the mark on the shaft of inserter) of the cemented stem that is to be implanted. Remove the assembly from the canal.

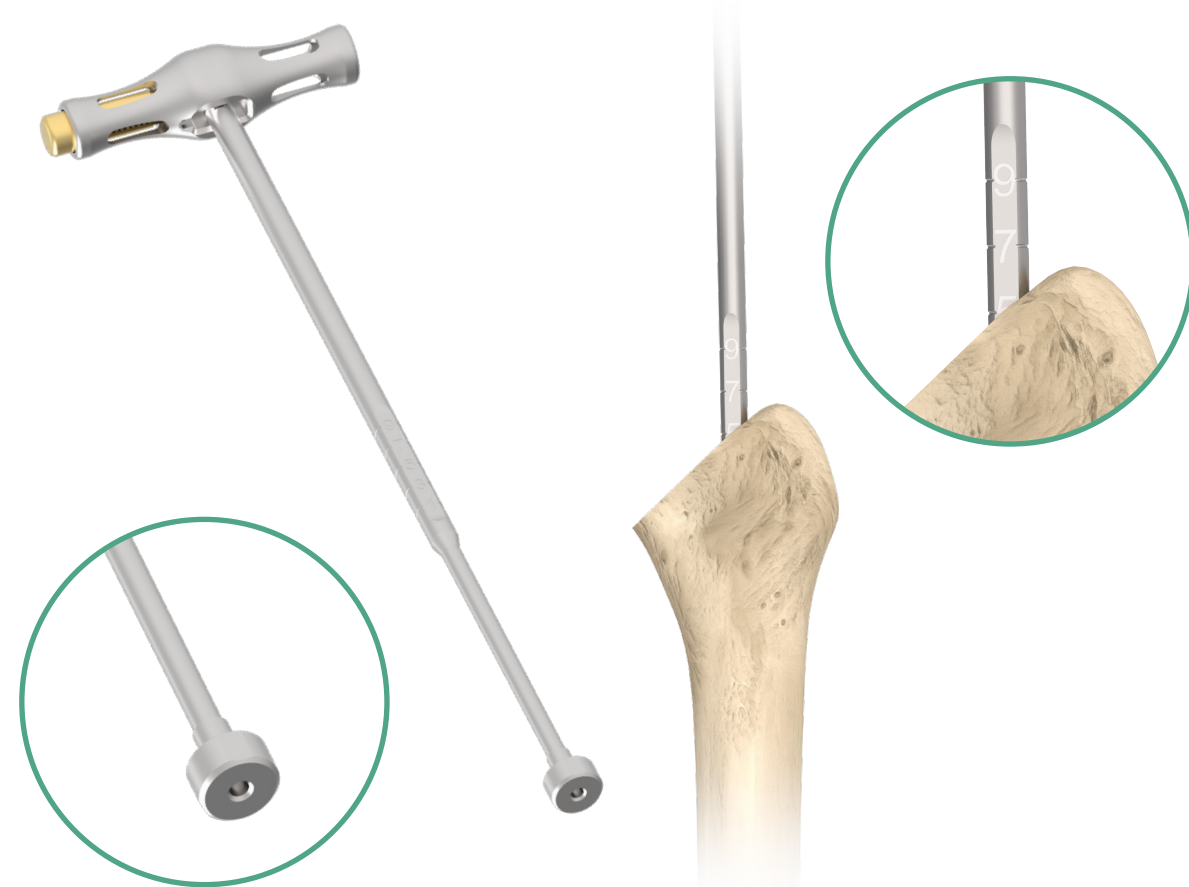

Instruments



Modular T Handle



Restrictor Inserter



Canal Sizer

Appendix

Cement Restrictor Insertion (Cemented Stem Only)

Replace the **Canal Sizer** using the appropriate cement restrictor. Introduce the restrictor into the canal to the designated depth (read the mark on the shaft of inserter). After the restrictor is located, dry the femoral canal by passing a swab down the canal. Remaining debris can also be removed during this procedure. The bone cement can then be introduced in low viscosity state. Cement can be injected in a retrograde fashion to gradually fill the canal.



Compatible with

Any product requiring a cement restrictor, most likely to be used with USTAR II System

| Cement Restrictor, I-Type | | |
|---------------------------|------|-----------------|
| Cat. No. | Size | Canal size (mm) |
| 1907-1008 | # 8 | 8 - 9 |
| 1907-1010 | # 10 | 10 - 11 |
| 1907-1012 | # 12 | 12 - 13 |
| 1907-1014 | # 14 | 14 - 15 |
| 1907-1016 | # 16 | 16 - 17 |
| 1907-1018 | # 18 | 18 - 19 |

Note:

To ensure the proper bone cement filling, please insert the restrictor prior to introducing the cemented stem.

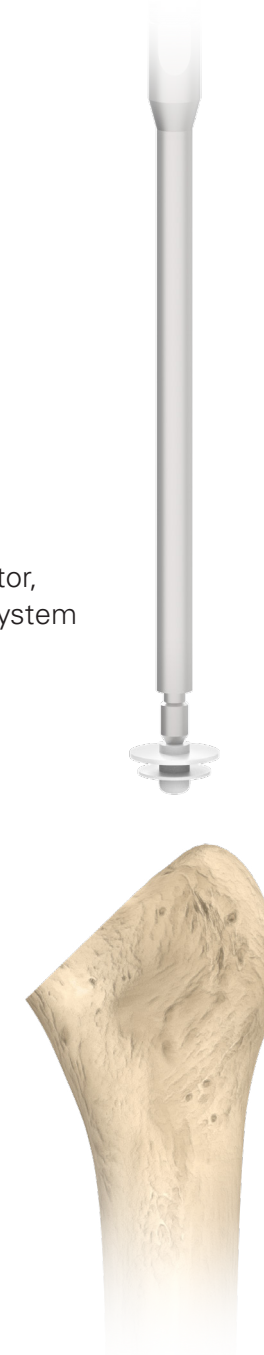

Instruments



Modular T Handle



Restrictor Inserter

Appendix

Cemented Stem Insertion (Cemented Stem Only)

Determination of stem size depends on surgeons' preference and patients' condition; the same stem size as the final broach (line-to-line, thin cement) or one size down (increased thickness of cement mantle) can be available for selection. Use the **Quick Connect Holder** to hold the cemented Conformity stem, and press the stem into the femoral canal until the adequate depth is reached (laser mark should be aligned with the resection surface). Remove the excessive cement. Hold the stem until the cement is polymerized, and disengage the **Quick Connect Holder**.

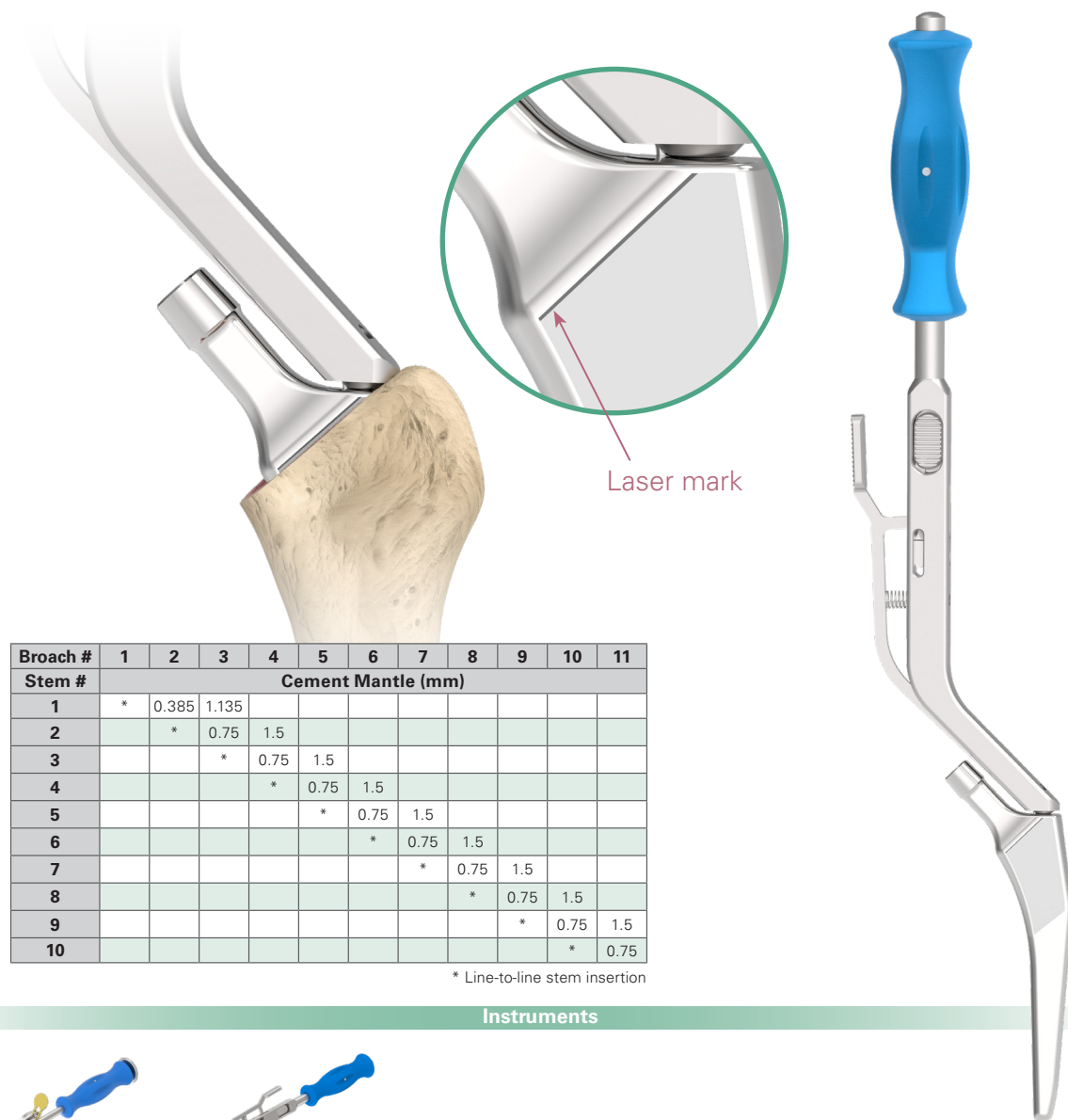

| Broach # | 1 | 2 | 3 | 4 | 5 | 6 | 7 | 8 | 9 | 10 | 11 |
|----------|--------------------|-------|-------|------|------|------|------|------|------|------|------|
| Stem # | Cement Mantle (mm) | | | | | | | | | | |
| 1 | * | 0.385 | 1.135 | | | | | | | | |
| 2 | | * | 0.75 | 1.5 | | | | | | | |
| 3 | | | * | 0.75 | 1.5 | | | | | | |
| 4 | | | | * | 0.75 | 1.5 | | | | | |
| 5 | | | | | * | 0.75 | 1.5 | | | | |
| 6 | | | | | | * | 0.75 | 1.5 | | | |
| 7 | | | | | | | * | 0.75 | 1.5 | | |
| 8 | | | | | | | | * | 0.75 | 1.5 | |
| 9 | | | | | | | | | * | 0.75 | 1.5 |
| 10 | | | | | | | | | | * | 0.75 |

* Line-to-line stem insertion

Instruments



**Straight Quick
Connect Holder**



**Offset Quick
Connect Holder**

Order Information

| Catalog Number | Description |
|----------------|-------------|
|----------------|-------------|

Conformity, Collared

Standard



High Offset



Standard

| | | |
|-------------|-------------|------|
| 1110 - 1001 | 1110 - 1201 | # 1 |
| 1110 - 1002 | 1110 - 1202 | # 2 |
| 1110 - 1003 | 1110 - 1203 | # 3 |
| 1110 - 1004 | 1110 - 1204 | # 4 |
| 1110 - 1005 | 1110 - 1205 | # 5 |
| 1110 - 1006 | 1110 - 1206 | # 6 |
| 1110 - 1007 | 1110 - 1207 | # 7 |
| 1110 - 1008 | 1110 - 1208 | # 8 |
| 1110 - 1009 | 1110 - 1209 | # 9 |
| 1110 - 1010 | 1110 - 1210 | # 10 |
| 1110 - 1011 | 1110 - 1211 | # 11 |

High Offset

Conformity, Collarless

Standard



High Offset



Standard

| | | |
|-------------|-------------|------|
| 1110 - 3001 | 1110 - 3201 | # 1 |
| 1110 - 3002 | 1110 - 3202 | # 2 |
| 1110 - 3003 | 1110 - 3203 | # 3 |
| 1110 - 3004 | 1110 - 3204 | # 4 |
| 1110 - 3005 | 1110 - 3205 | # 5 |
| 1110 - 3006 | 1110 - 3206 | # 6 |
| 1110 - 3007 | 1110 - 3207 | # 7 |
| 1110 - 3008 | 1110 - 3208 | # 8 |
| 1110 - 3009 | 1110 - 3209 | # 9 |
| 1110 - 3010 | 1110 - 3210 | # 10 |
| 1110 - 3011 | 1110 - 3211 | # 11 |

High Offset

Conformity, Coxa Vara



Coxa Vara

| | |
|-------------|------|
| 1110 - 5202 | # 2 |
| 1110 - 5203 | # 3 |
| 1110 - 5204 | # 4 |
| 1110 - 5205 | # 5 |
| 1110 - 5206 | # 6 |
| 1110 - 5207 | # 7 |
| 1110 - 5208 | # 8 |
| 1110 - 5209 | # 9 |
| 1110 - 5210 | # 10 |
| 1110 - 5211 | # 11 |

Conformity, Short Neck



Short Neck

| | |
|-------------|-----|
| 1110 - 1401 | # 1 |
| 1110 - 1402 | # 2 |
| 1110 - 1403 | # 3 |

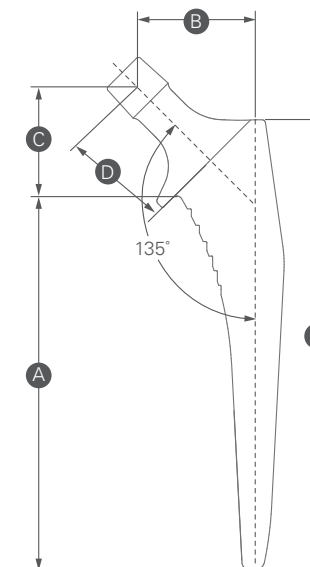
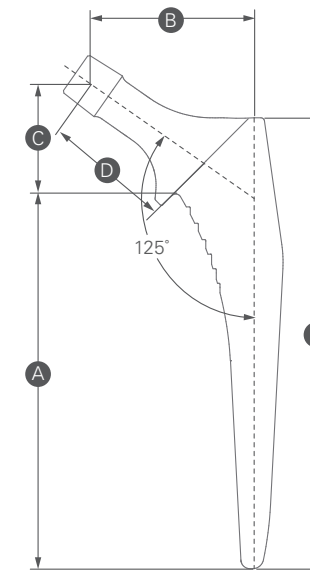
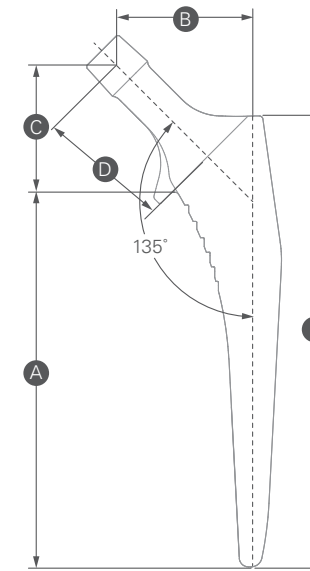

Collared & Collarless

| Size | A Medial Length | B Offset | | C Vertical Height | D Neck Length | | E Lateral Length |
|------|--------------------|-------------|-------------|----------------------|------------------|-------------|---------------------|
| | | Standard | High Offset | | Standard | High Offset | |
| #1 | 95.0 | 36.0 | 43.0 | 34.0 | 35.5 | 40.5 | 115.0 |
| #2 | 99.5 | 36.5 | 43.5 | 34.0 | 35.5 | 40.5 | 119.5 |
| #3 | 104.0 | 37.5 | 44.5 | 34.0 | 35.5 | 40.5 | 124.0 |
| #4 | 108.5 | 38.0 | 45.0 | 34.0 | 35.5 | 40.5 | 128.5 |
| #5 | 113.0 | 39.0 | 46.0 | 34.0 | 35.5 | 40.5 | 133.0 |
| #6 | 117.5 | 39.5 | 46.5 | 34.0 | 35.5 | 40.5 | 137.5 |
| #7 | 122.0 | 40.0 | 47.0 | 34.0 | 35.5 | 40.5 | 142.0 |
| #8 | 126.5 | 41.0 | 48.0 | 34.0 | 35.5 | 40.5 | 146.5 |
| #9 | 131.0 | 41.5 | 48.5 | 34.0 | 35.5 | 40.5 | 151.0 |
| #10 | 135.5 | 42.5 | 49.5 | 34.0 | 35.5 | 40.5 | 155.5 |
| #11 | 140.0 | 43.5 | 50.5 | 34.0 | 35.5 | 40.5 | 160.0 |

Unit : mm

Coxa Vara

| Size | A Medial Length | B Offset | C Vertical Height | D Neck Length | E Lateral Length |
|------|--------------------|-------------|----------------------|------------------|---------------------|
| #2 | 99.5 | 43.5 | 29.0 | 37.5 | 119.5 |
| #3 | 104.0 | 44.5 | 29.0 | 37.5 | 124.0 |
| #4 | 108.5 | 45.0 | 29.0 | 37.5 | 128.5 |
| #5 | 113.0 | 46.0 | 29.0 | 37.5 | 133.0 |
| #6 | 117.5 | 46.5 | 29.0 | 37.5 | 137.5 |
| #7 | 122.0 | 47.0 | 29.0 | 37.5 | 142.0 |
| #8 | 126.5 | 48.0 | 29.0 | 37.5 | 146.5 |
| #9 | 131.0 | 48.5 | 29.0 | 37.5 | 151.0 |
| #10 | 135.5 | 49.5 | 29.0 | 37.5 | 155.5 |
| #11 | 140.0 | 50.5 | 29.0 | 37.5 | 160.0 |

Unit : mm

Short Neck

| Size | A Medial Length | B Offset | C Vertical Height | D Neck Length | E Lateral Length |
|------|--------------------|-------------|----------------------|------------------|---------------------|
| #1 | 95.0 | 31.0 | 29.0 | 28.5 | 115.0 |
| #2 | 99.5 | 31.5 | 29.0 | 28.5 | 119.5 |
| #3 | 104.0 | 32.5 | 29.0 | 28.5 | 124.0 |

Unit : mm

Order Information

| Catalog Number | Description |
|----------------|-------------|
|----------------|-------------|

Conformity, Cemented Standard



High Offset



Standard

| | | |
|-------------|-------------|------|
| 1110 - 7001 | 1110 - 7201 | # 1 |
| 1110 - 7002 | 1110 - 7202 | # 2 |
| 1110 - 7003 | 1110 - 7203 | # 3 |
| 1110 - 7004 | 1110 - 7204 | # 4 |
| 1110 - 7005 | 1110 - 7205 | # 5 |
| 1110 - 7006 | 1110 - 7206 | # 6 |
| 1110 - 7007 | 1110 - 7207 | # 7 |
| 1110 - 7008 | 1110 - 7208 | # 8 |
| 1110 - 7009 | 1110 - 7209 | # 9 |
| 1110 - 7010 | 1110 - 7210 | # 10 |

High Offset

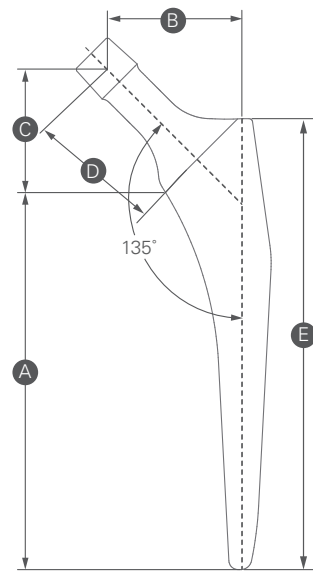

| Size | A Medial Length | B Offset | | C Vertical Height | D Neck Length | | E Lateral Length |
|------|-----------------------|-------------|-------------|-------------------------|---------------------|-------------|------------------------|
| | | Standard | High Offset | | Standard | High Offset | |
| #1 | 95.0 | 36.0 | 43.0 | 34.0 | 35.5 | 40.5 | 115.0 |
| #2 | 99.5 | 36.5 | 43.5 | 34.0 | 35.5 | 40.5 | 119.5 |
| #3 | 104.0 | 37.5 | 44.5 | 34.0 | 35.5 | 40.5 | 124.0 |
| #4 | 108.5 | 38.0 | 45.0 | 34.0 | 35.5 | 40.5 | 128.5 |
| #5 | 113.0 | 39.0 | 46.0 | 34.0 | 35.5 | 40.5 | 133.0 |
| #6 | 117.5 | 39.5 | 46.5 | 34.0 | 35.5 | 40.5 | 137.5 |
| #7 | 122.0 | 40.0 | 47.0 | 34.0 | 35.5 | 40.5 | 142.0 |
| #8 | 126.5 | 41.0 | 48.0 | 34.0 | 35.5 | 40.5 | 146.5 |
| #9 | 131.0 | 41.5 | 48.5 | 34.0 | 35.5 | 40.5 | 151.0 |
| #10 | 135.5 | 42.5 | 49.5 | 34.0 | 35.5 | 40.5 | 155.5 |

Unit : mm

Order Information

| Catalog Number | Size | Canal Size (mm) |
|----------------|------|-----------------|
|----------------|------|-----------------|

Cement Restrictor, I-Type



| | | |
|-------------|------|---------|
| 1907 - 1008 | # 8 | 8 - 9 |
| 1907 - 1010 | # 10 | 10 - 11 |
| 1907 - 1012 | # 12 | 12 - 13 |
| 1907 - 1014 | # 14 | 14 - 15 |
| 1907 - 1016 | # 16 | 16 - 17 |
| 1907 - 1018 | # 18 | 18 - 19 |

Femoral Head

| | Catalog Number | Description (mm) |
|---|----------------|------------------|
| U2 Femoral Head  | 1206 - 1122 | * Ø 22 + 0 |
| | 1206 - 1322 | * Ø 22 + 3 |
| | 1206 - 1522 | * Ø 22 + 6 |
| | 1206 - 1722 | * Ø 22 + 9 |
| | 1206 - 1026 | Ø 26 - 2 |
| | 1206 - 1126 | Ø 26 + 0 |
| | 1206 - 1326 | Ø 26 + 3 |
| | 1206 - 1526 | Ø 26 + 6 |
| | 1206 - 1726 | Ø 26 + 9 |
| | 1206 - 1028 | Ø 28 - 3 |
| | 1206 - 1128 | Ø 28 + 0 |
| | 1206 - 1228 | Ø 28 + 2.5 |
| | 1206 - 1428 | Ø 28 + 5 |
| | 1206 - 1628 | Ø 28 + 7.5 |
| | 1206 - 1828 | Ø 28 + 10 |
| | 1206 - 1032 | Ø 32 - 3 |
| | 1206 - 1132 | Ø 32 + 0 |
| | 1206 - 1232 | Ø 32 + 2.5 |
| | 1206 - 1432 | Ø 32 + 5 |
| | 1206 - 1632 | Ø 32 + 7.5 |
| | 1206 - 1832 | Ø 32 + 10 |
| | 1206 - 1036 | Ø 36 - 3 |
| | 1206 - 1136 | Ø 36 + 0 |
| | 1206 - 1236 | Ø 36 + 2.5 |
| | 1206 - 1436 | Ø 36 + 5 |
| | 1206 - 1636 | Ø 36 + 7.5 |
| | 1206 - 1836 | Ø 36 + 10 |

* The actual spherical diameter of a 22 mm metal head is 22.2 mm.

Femoral Head

| | Catalog Number | Description (mm) |
|--|----------------|------------------|
| BIOLOX® delta Ceramic Head  | 1203 - 5028 | Ø 28 S - 2.5 |
| | 1203 - 5228 | Ø 28 M + 1 |
| | 1203 - 5428 | Ø 28 L + 4 |
| | 1203 - 5032 | Ø 32 S - 3 |
| | 1203 - 5232 | Ø 32 M + 1 |
| | 1203 - 5432 | Ø 32 L + 5 |
| | 1203 - 5632 | Ø 32 XL + 8 |
| | 1203 - 5036 | Ø 36 S - 3 |
| | 1203 - 5236 | Ø 36 M + 1 |
| | 1203 - 5436 | Ø 36 L + 5 |
| | 1203 - 5636 | Ø 36 XL + 9 |
| | 1203 - 5040 | Ø 40 S - 3 |
| | 1203 - 5240 | Ø 40 M + 1 |
| | 1203 - 5440 | Ø 40 L + 5 |
| | 1203 - 5640 | Ø 40 XL + 9 |

*BIOLOX® is a registered trademark of the CeramTec Group, Germany

Please note that this Surgical Technique Guide has been authored in the English language. Any translations into other languages have not been reviewed or approved by United Orthopedic Corporation and their accuracy cannot be confirmed. Any translated guide should be reviewed carefully prior to use and questions regarding a Surgical Technique Guide should be directed to United Orthopedic Corporation at unitedorthopedic.com/contact

The CE mark is valid only if it is also printed on the product label.

